

MOMENTI.

NIGHT SPACE

febal
casa

IT

La camera e il living si reinventano riscritti dal nuovo alfabeto di una collezione dal design contemporaneo e dall'animo sistemico.

Stile e funzionalità si uniscono in un concept d'arredo basato sulla trasversalità delle finiture e sul potere creativo della modularità.

Un dialogo vivace ed eclettico tra la zona giorno e quella notte.

EN

The bedroom and living area are reinvented by the new lexicon of a collection with a contemporary design and holistic spirit.

Style and practicality come together in a furnishing concept based on versatile finishes and the creative power of modularity. A vibrant and eclectic dialogue between the living area and bedroom.

- p.5 **Introduzione**
Introduction
- p.9 **L'habitat contemporaneo
giovane e dinamico**
The young and dynamic contemporary habitat
- p.71 **La residenza calda e materica**
The warm and textured residence
- p.137 **L'appartamento d'epoca tra ieri e oggi**
The period apartment of past and present
- p.197 **Il loft essenziale e luminoso**
The bright and essential loft
- p.243 **Complementi**
Accessories
- p.263 **Finiture**
Finishes
- p.268 **Indice composizioni**
Index of compositions

Quattro case, quattro mondi che raccontano esigenze abitative e personalità differenti. Locali piccoli e contenuti oppure ampi e importanti, ambienti storici oppure moderni.

Questo catalogo interpreta la camera attraverso quattro stili diversi che esaudiscono il medesimo desiderio di comfort e relax della zona notte e la necessità di soluzioni che contengono e ottimizzano.

Configurazioni che poi trovano continuità nelle possibilità progettuali della zona living.

Four homes, four worlds, each with their own set of living needs and personalities. Small and compact rooms, or else large and spacious, historic or contemporary settings.

This catalogue interprets the bedroom through four distinct styles fulfilling the same desire for comfort and relaxation in the bedroom, together with the need for solutions that both contain and optimise.

Configurations that enjoy continuity in the design possibilities of the living area.

L'habitat contemporaneo giovane e dinamico.
Legno, luce, delicatezza.
La calda naturalità dello stile nordico.

The young and dynamic contemporary habitat.
Wood, light, delicacy.
The warm naturalness of the Nordic style.



→ vedi catalogo Living Space
→ see Living Space catalogue

NIGHT SPACE → p.9
ZONA NOTTE → p.9

La residenza calda e materica.
Toccare, sentire, vivere.
La casa che invita ed accoglie.

The warm and textured residence.
Touch, feel, live.
The home that invites and welcomes.



→ vedi catalogo Living Space
→ see Living Space catalogue

NIGHT SPACE → p.71
ZONA NOTTE → p.71

L'appartamento d'epoca tra ieri e oggi.
Eleganza e fruibilità.
Atmosfere lontane e quotidianità moderne.

The period apartment of past and present.
Elegance and usability.
Bygone atmospheres and modern life.

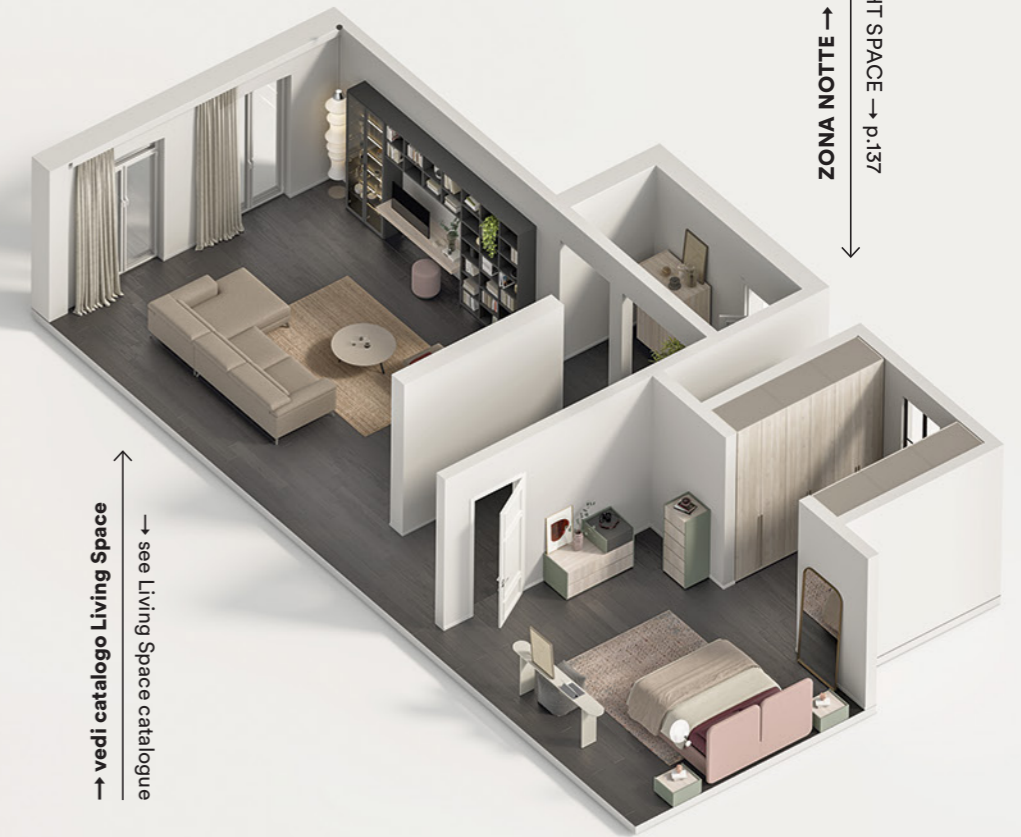

→ vedi catalogo Living Space
→ see Living Space catalogue

NIGHT SPACE → p.137
ZONA NOTTE → p.137

Il loft essenziale e luminoso.
Comodità e carattere per ambienti aperti.

The bright and essential loft.
Comfort and character for open spaces.



→ vedi catalogo Living Space
→ see Living Space catalogue

NIGHT SPACE → p.197
ZONA NOTTE → p.197

N01

Spazi importanti e aperti,
un mix di texture e finiture
dai colori tenui e desaturati
intervallati da legni caldi.
Il letto al centro della stanza,
gli armadi a disegnarne lo spazio.

Large open spaces with
a variety of textures and
finishes in soft, desaturated
colours, interspersed
with warm woods.
The bed at the centre
of the room, the wardrobes
that outline the space.



SCOPRI LE ALTRE COMPOSIZIONI → p.22

SEE THE OTHER COMPOSITIONS → p.22





IT
 Armadio con anta battente Concreta, consolle e maniglia Pul, letto Alba con alzatina retro testata, gruppo Laguna.

EN
 Wardrobe with Concreta swing door, console and Pul handle, Alba bed with rear headboard console table, Laguna set.





LETTO ALBA | ALBA BED

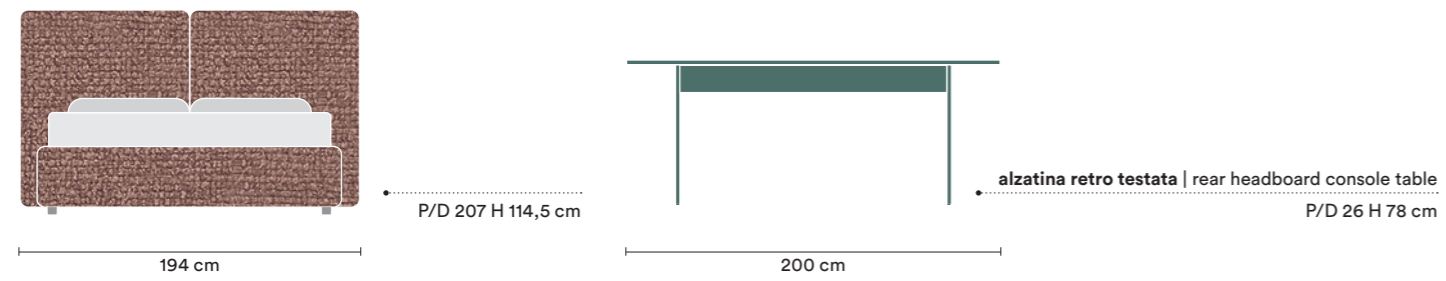

GRUPPO LAGUNA | LAGUNA SET

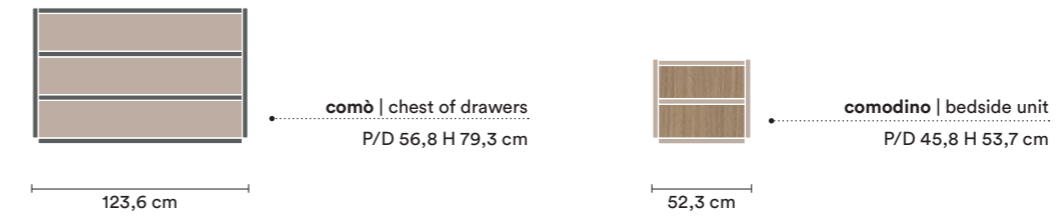

**ARMADIO ANTA BATTENTE CONCRETA E CONSOLLE
| WARDROBE WITH CONCRETA SWING DOOR AND CONSOLE**

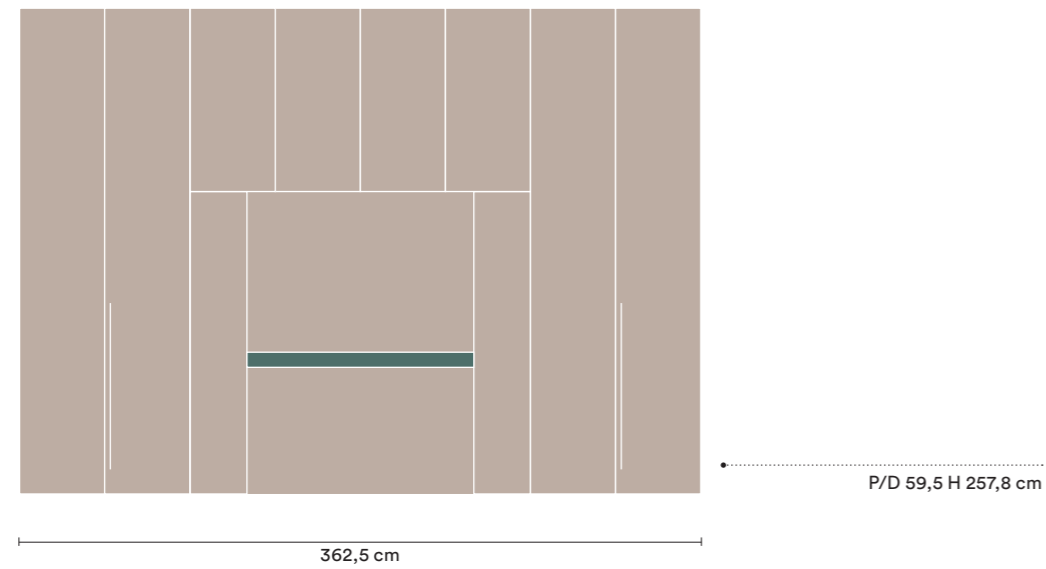

**ARMADIO ANTA BATTENTE CONCRETA CON FIANCO TELAIO ALLUMINIO
| WARDROBE WITH CONCRETA SWING DOOR AND CONSOLE AND ALUMINIUM SIDE FRAME**

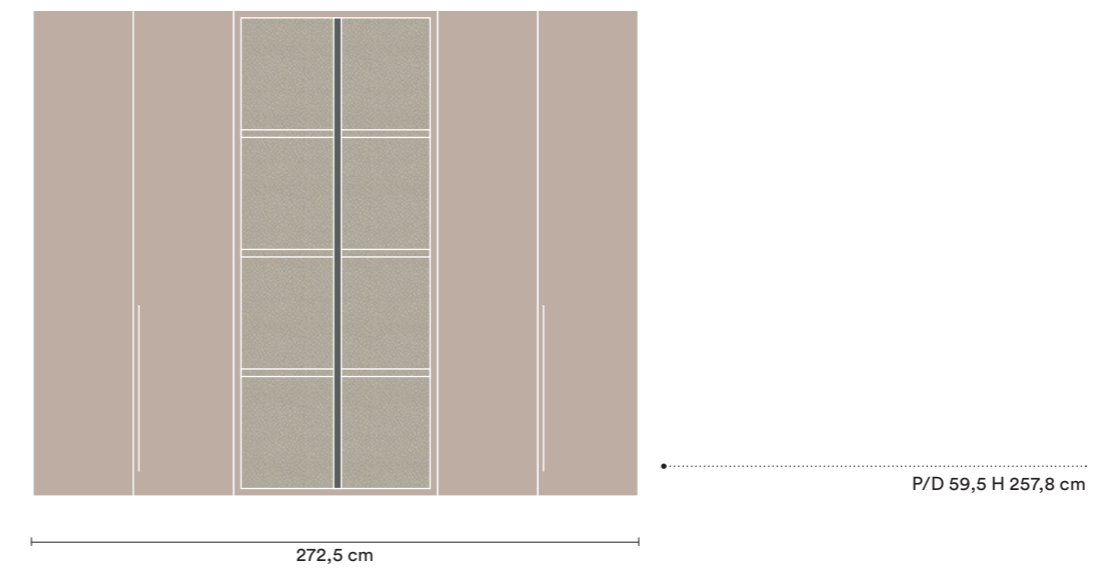

FINITURE | FINISHES

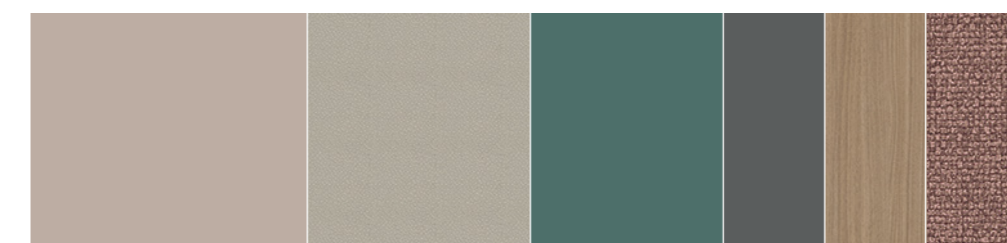

Canapa
Leather grey
Verde Alpi
Grigio titanio
Noce
Jenny Coriander

N02



IT
 Armadio con anta battente Window, letto Darsena, gruppo Tower, basi a terra con anta One.

EN
 Wardrobe with Window swing door, Darsena bed, Tower set, floor-standing base units with One door.





LETTO DARSENA | DARSENA BED

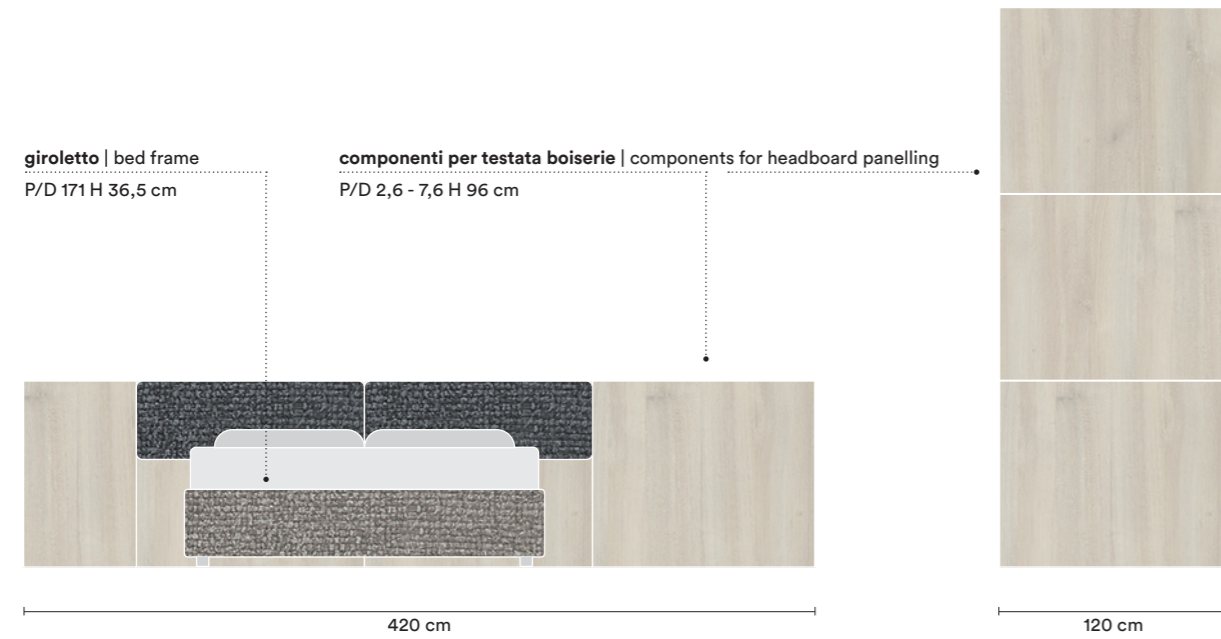

BASI A TERRA | FLOOR-STANDING BASE UNITS

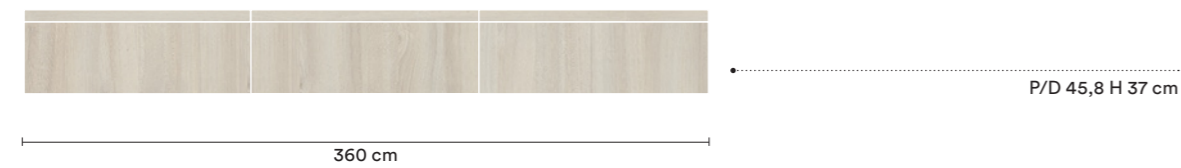

GRUPPO TOWER | TOWER SET

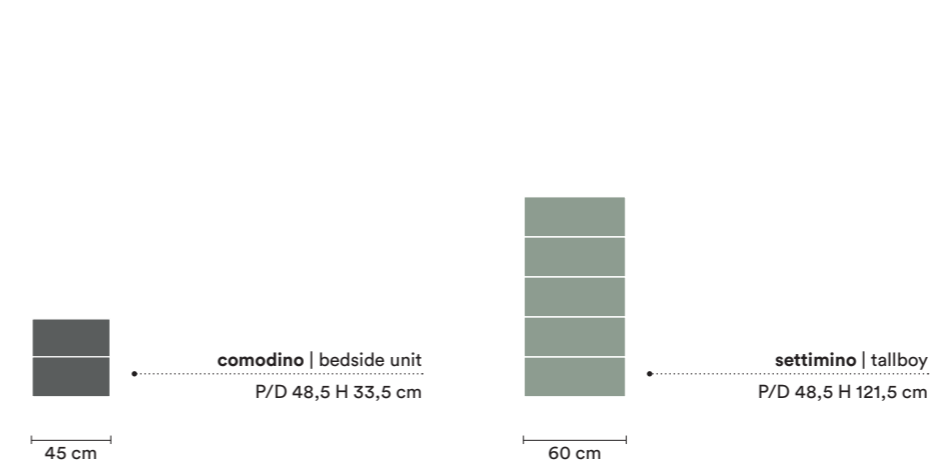

ARMADIO ANTA BATTENTE WINDOW | WARDROBE WITH WINDOW SWING DOOR

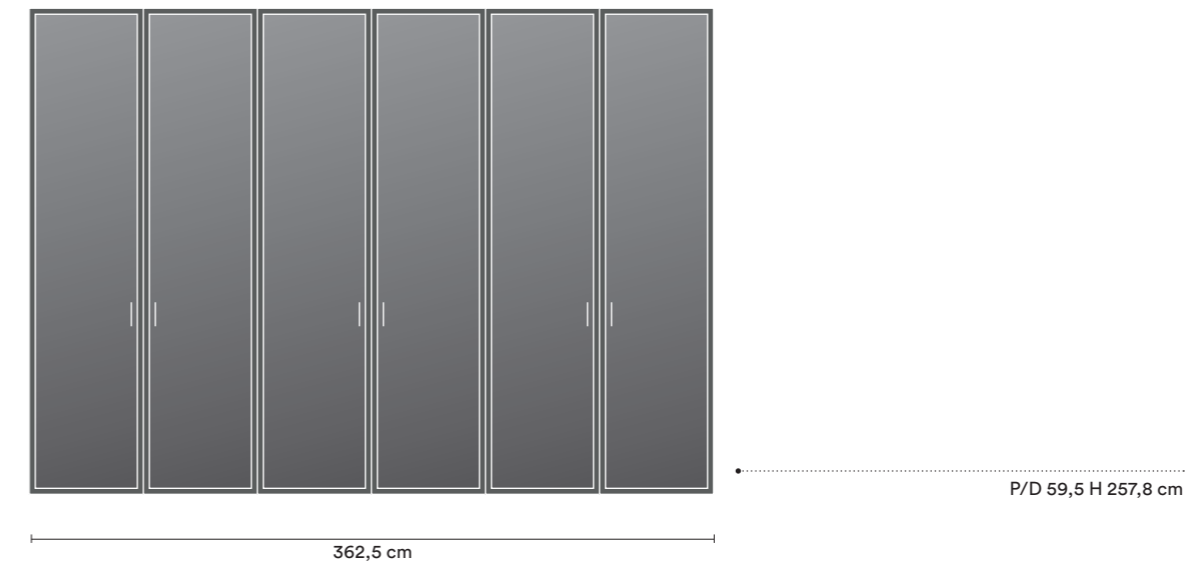

FINITURE | FINISHES



Ciliegio bianco
Agave
Grigio titanio
Jenny Smoke
Jenny Grey

N03



IT
 Libreria *Infinity* a terra profondità 33,3 cm con vano tv e per passaggio con anta a soffietto e anta battente *Club*, guardaroba *Flexo*, letto *Kiss*, gruppo *Brick*.

EN
Infinity floor-standing bookshelf, depth 33.3 cm with TV housing space and through-space with folding door and *Club* swing door, *Flexo* walk-in, *Kiss* bed, *Brick* set.





LETTO KISS | KISS BED

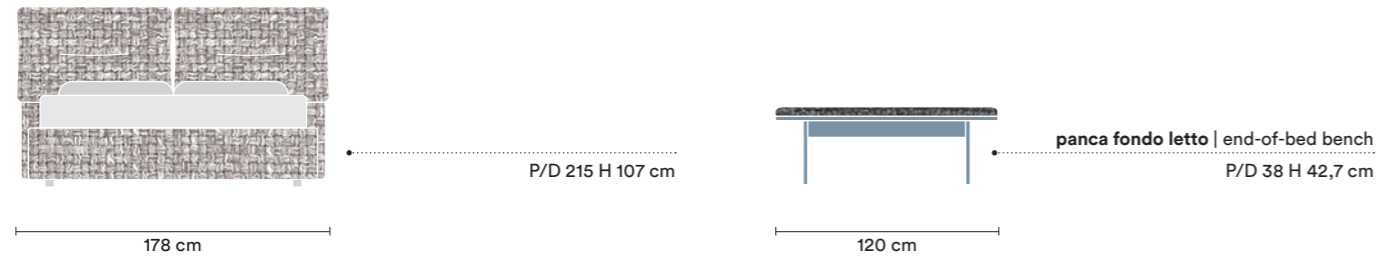

GRUPPO BRICK | BRICK SET

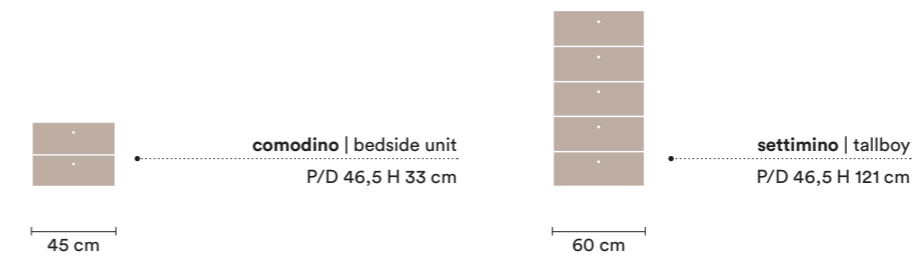

GUARDAROBA FLEVO | FLEVO WALK-IN CLOSET

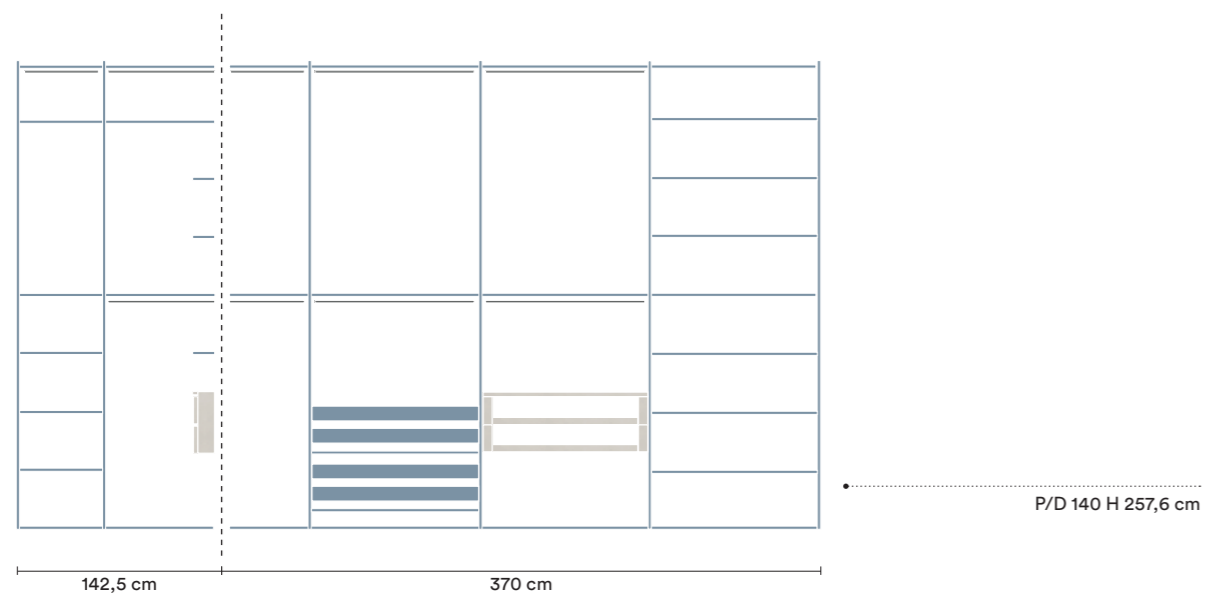

LIBRERIA INFINITY | INFINITY BOOKSHELF



FINITURE | FINISHES



- Noce
- Cadaques
- Canapa
- Rovere Dorian
- Ecochic Dorian
- Jenny Smoke

N04

IT
Armadio con anta scorrevole Style, letto Adagio, gruppo Label.

EN
Wardrobe with Style sliding door, Adagio bed, Label set.







LETTO ADAGIO | ADAGIO BED

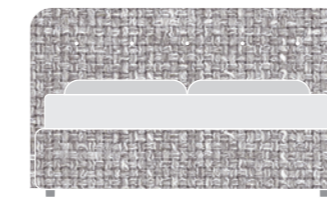

180 cm

P/D 225 H 108 cm

GRUPPO LABEL | LABEL SET



126,6 cm



54,6 cm

comò | chest of drawers
P/D 45,2 H 74,8 cm

comodino | bedside unit
P/D 45,2 H 50,9 cm

ARMADIO ANTA SCORREVOLE STYLE | WARDROBE WITH STYLE SLIDING DOOR

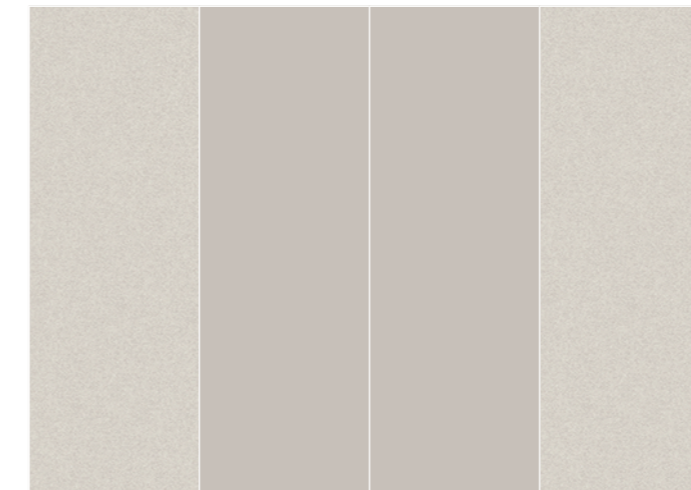

362,5 cm

P/D 59,5 H 257,8 cm

FINITURE | FINISHES

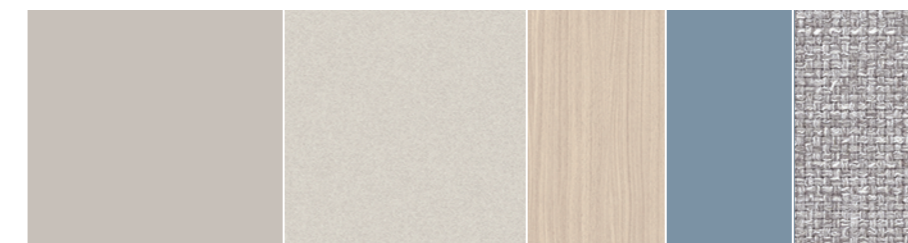

Grigio Dorian
Feltro
Noce naturale
Cadaques
Ecochic Dorian

N05

IT
 Armadio con anta scorrevole Inserto,
 sistema boiserie Pepita, giroletto
Marte, gruppo Gape, basi a terra
 e pensili con anta One.

EN
 Wardrobe with Inserto sliding door,
Pepita panelling system, Marte bed
 frame, Gape set, floor-standing base
 units and wall units with One door.







GIROLETTO MARTE E SISTEMA BOISERIE PEPITA | MARTE BED FRAME AND PEPITA PANELLING SYSTEM

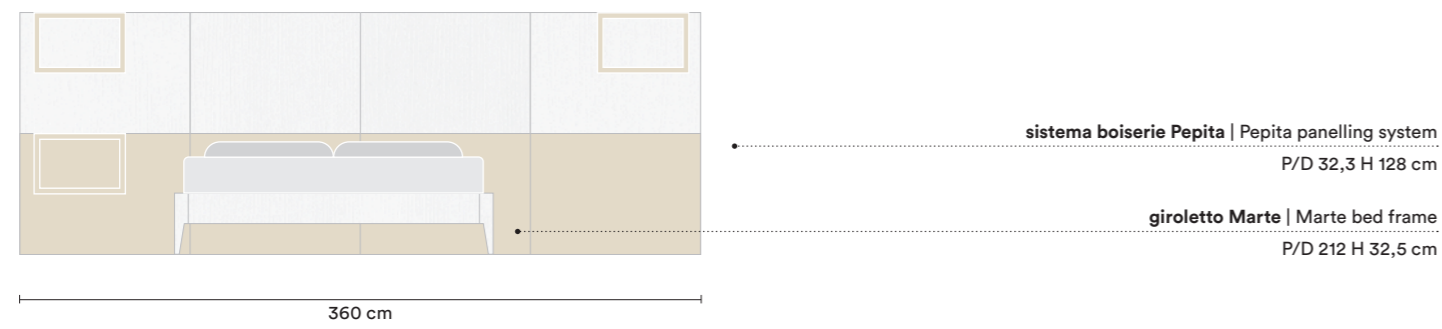

GRUPPO GAPE | GAPE SET

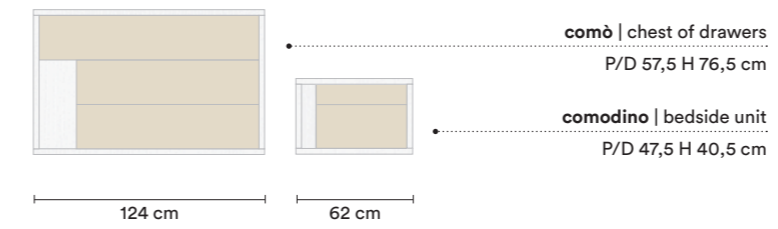

BASI A TERRA E PENSILI CON ANTA ONE | FLOOR-STANDING BASE UNITS AND WALL UNITS WITH ONE DOOR

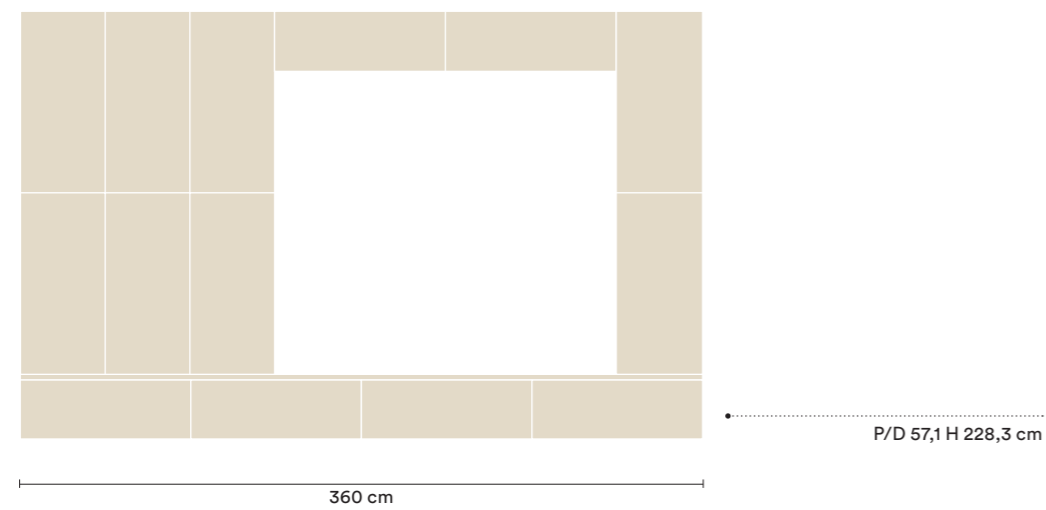

ARMADIO ANTA SCORREVOLE INSERTO | WARDROBE WITH INSERTO SLIDING DOOR

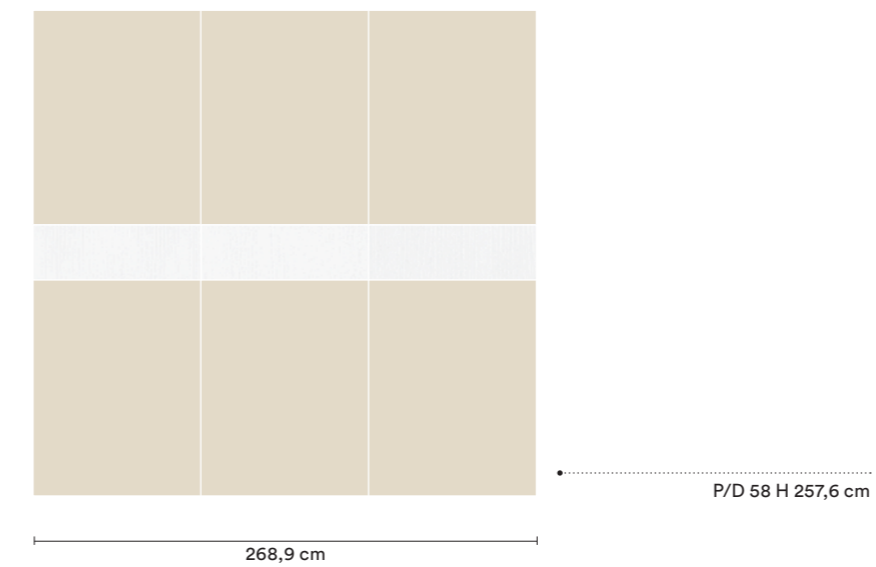

FINITURE | FINISHES

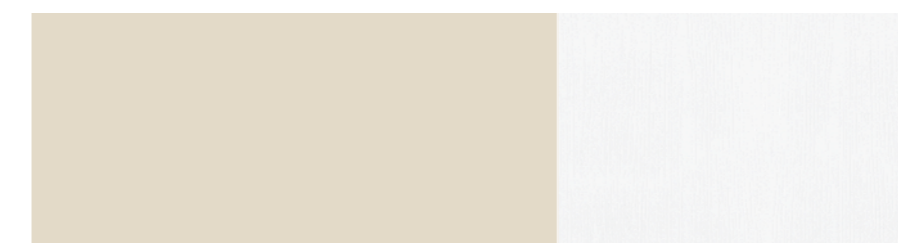

Desert
Rovere white

N06

IT
 Armadio con anta battente Concreta, vano porta tv e maniglia Ines, letto Time e gruppo Look su piedini Nume.

EN
 Wardrobe with Concreta swing door, TV housing space and Ines handle, Time bed and Look set on Nume feet.





LETTO TIME | TIME BED

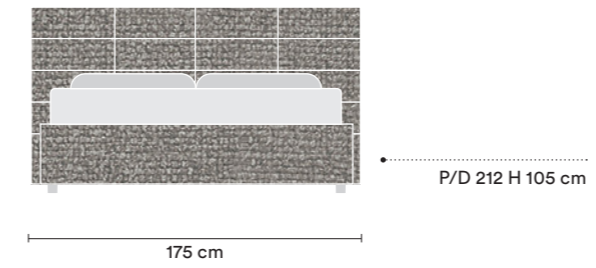

GRUPPO LOOK | LOOK SET

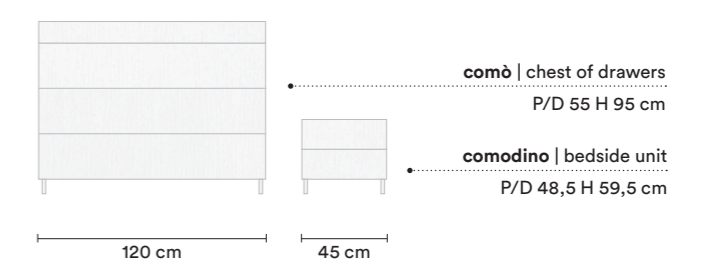

ARMADIO ANTA BATTENTE CONCRETA | WARDROBE WITH CONCRETA SWING DOOR



FINITURE | FINISHES



N07

IT
 Armadio con anta battente One
 e maniglia Pul, nicchia e taglio mansardato,
 letto Mushy con alloggiamento posteriore
 e giroletto Marte, gruppo Tower
 su piedini Epsilon e libreria Up&Up.

EN
 Wardrobe with One swing door
 and Pul handle, niche and pitched roof cut,
Mushy bed with rear compartment
 and Marte bed frame, Tower set
 on Epsilon feet and Up&Up bookshelf.







LETTO MUSHY | MUSHY BED

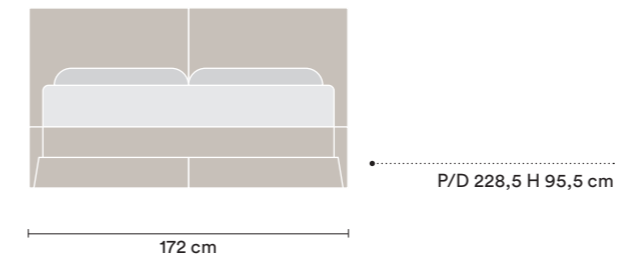

GRUPPO TOWER | TOWER SET

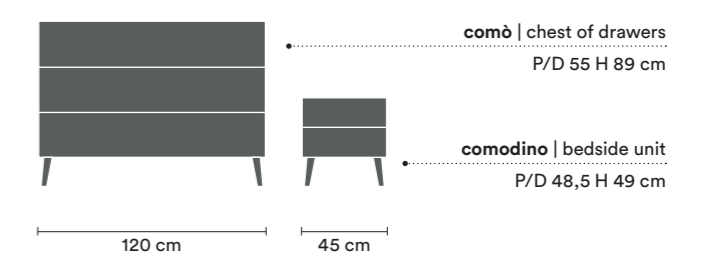

ARMADIO ANTA BATTENTE ONE
| WARDROBE WITH ONE SWING DOOR

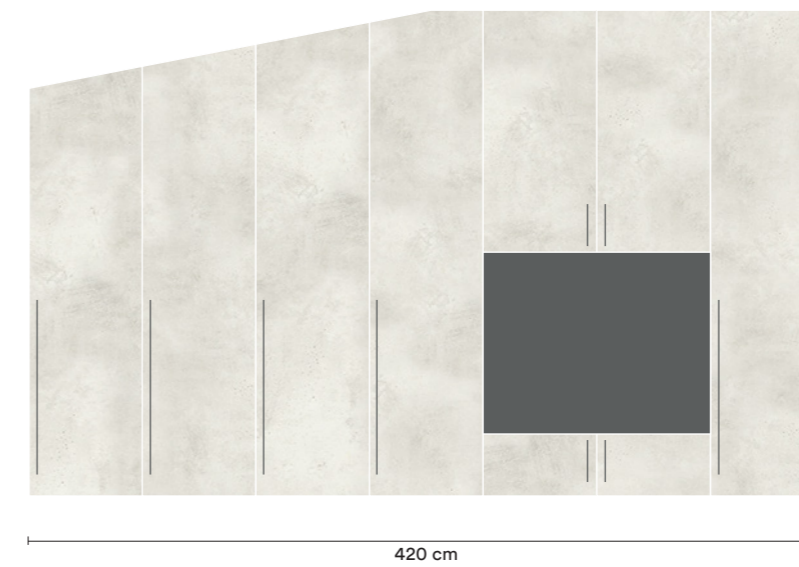

LIBRERIA UP&UP
| UP&UP BOOKSHELF

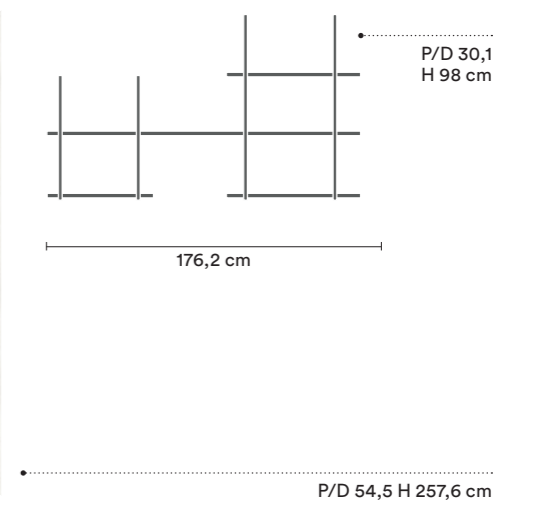

FINITURE | FINISHES

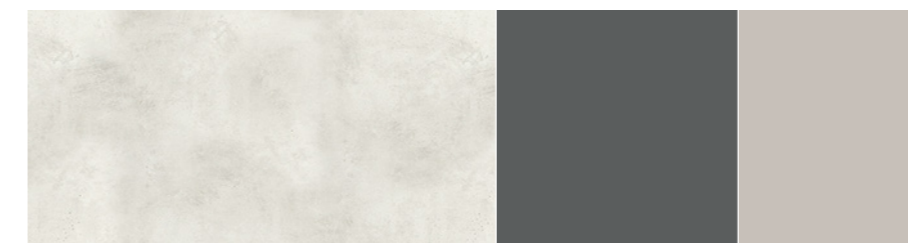

Malta
Grigio titanio
Grigio Dorian

N08

IT
 Armadio ad angolo con anta battente Club,
 ponte Rialto e libreria di sostegno Smart,
 letto Kant, gruppo Bold su piedini Nume,
 sistema boiserie Pepita e scrivania Podio.

EN
 Corner wardrobe with Club swing door,
Rialto overhead wardrobe and Smart
 support bookshelf, Kant bed, Bold set
 on Nume feet, Pepita panelling system
 and Podio desk.







GIROLETTO KANT | KANT BED

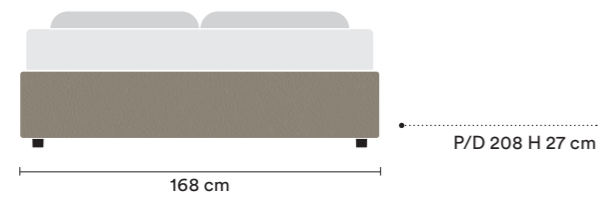

GRUPPO BOLD | BOLD SET

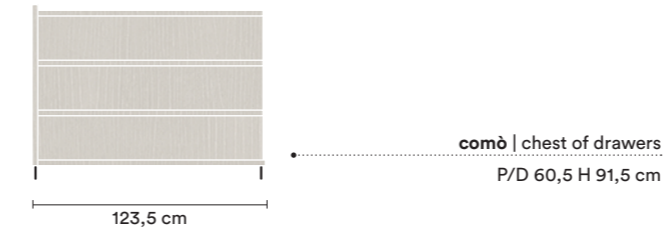

ARMADIO ANTA BATTENTE CLUB | WARDROBE WITH CLUB SWING DOOR

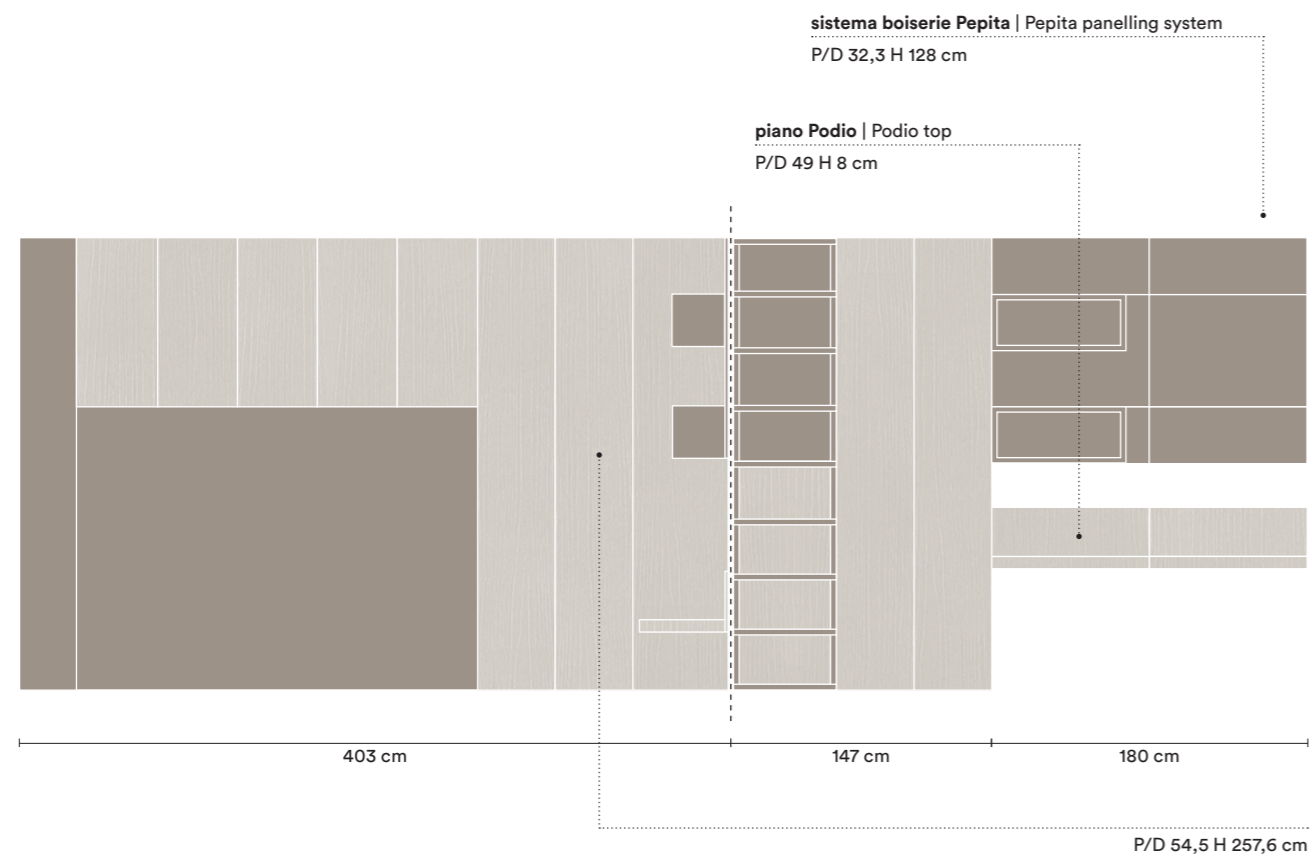

FINITURE | FINISHES



Rovere Dorian
Basalto
Ecochic Limo

N09

Un mix di materiali e dettagli studiato per restituire un senso di calore e benessere. La boiserie è resa più coinvolgente e architettonica dall'utilizzo del Noce. Le scelte dei tessuti conferiscono accoglienza all'ambiente. Le ante dell'armadio a due finiture ritmano e danno carattere allo spazio.

A mix of materials and details designed to restore a sense of warmth and wellness. More engaging and architectural panelling thanks to the use of Noce. The choice of fabrics lends cosiness to the room. The two-toned wardrobe doors add rhythm and flair to the space.



SCOPRI LE ALTRE COMPOSIZIONI → p.80

SEE THE OTHER COMPOSITIONS → p.80





IT
 Armadio con anta scorrevole
 Freedom, letto Darsena,
 gruppo Quadro.

EN
 Wardrobe with Freedom
 sliding door, Darsena bed,
 Quadro set.





LETTO DARSENA | DARSENA BED

giroletto | bed frame
P/D 171 H 36,5 cm

componenti per testata boiserie
| components for headboard panelling
P/D 2,6 - 7,6 - 28,6 H 96 cm

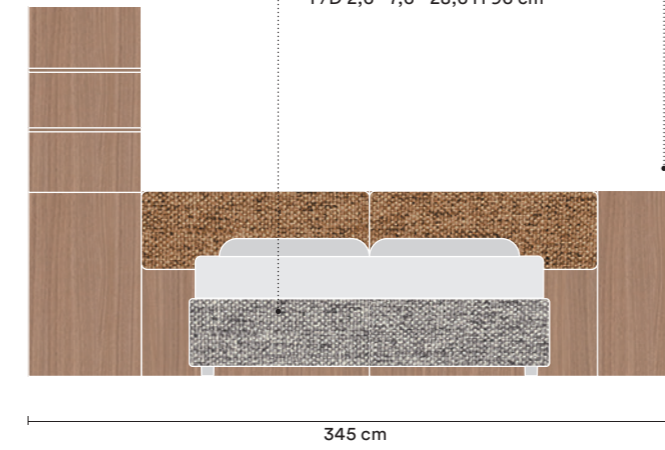

GRUPPO QUADRO | QUADRO SET

comò | chest of drawers
P/D 47,5 H 100,5 cm

comodino | bedside unit
P/D 47,5 H 40,5 cm

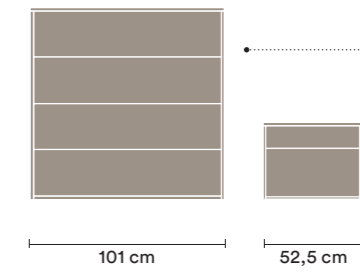

ARMADIO ANTA SCORREVOLE FREEDOM | WARDROBE WITH FREEDOM SLIDING DOOR



P/D 59,5 H 257,8 cm

FINITURE | FINISHES



Noce
Basalto
Rovere Dorian
Kenya Camel
Kenya Taupe

N10



IT
Armadio con anta scorrevole
Rail, letto Darsena, gruppo
Laguna.

EN
Wardrobe with Rail sliding
door, Darsena bed,
Laguna set.





LETTO DARSENA | DARSENA BED

GRUPPO LAGUNA | LAGUNA SET

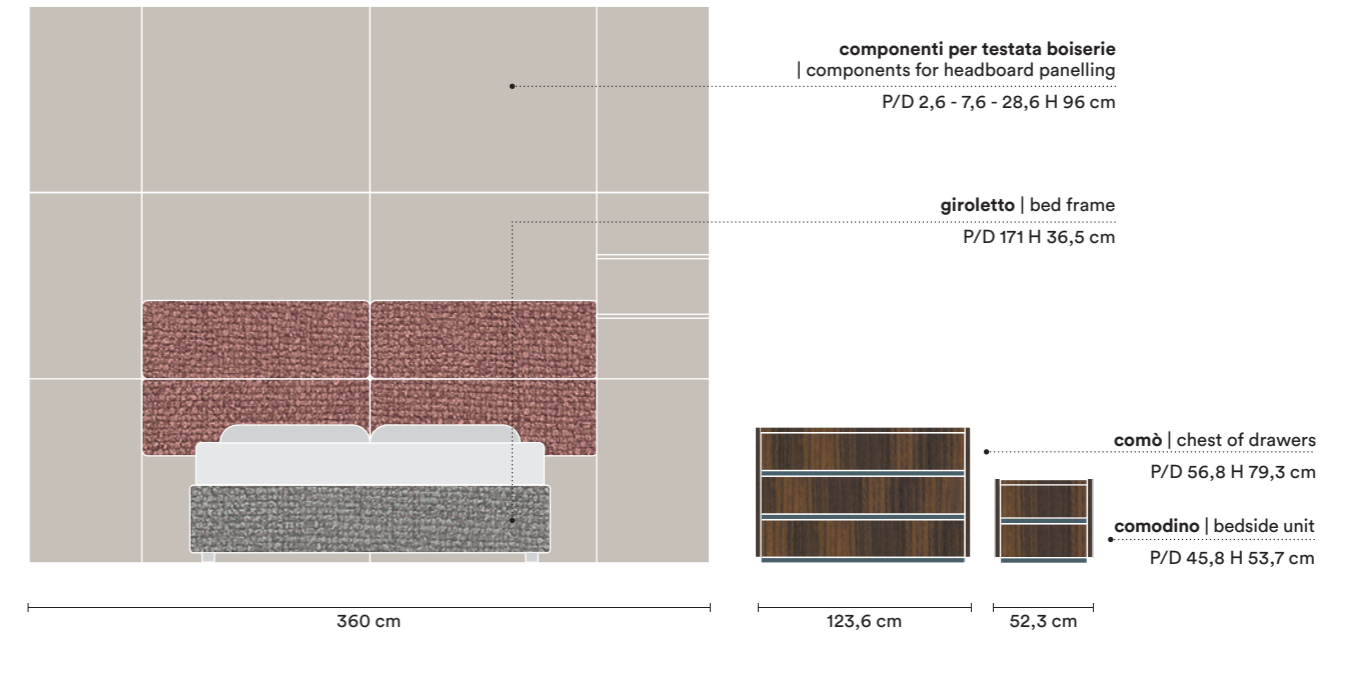

ARMADIO ANTA SCORREVOLE RAIL | WARDROBE WITH RAIL SLIDING DOOR



FINITURE | FINISHES

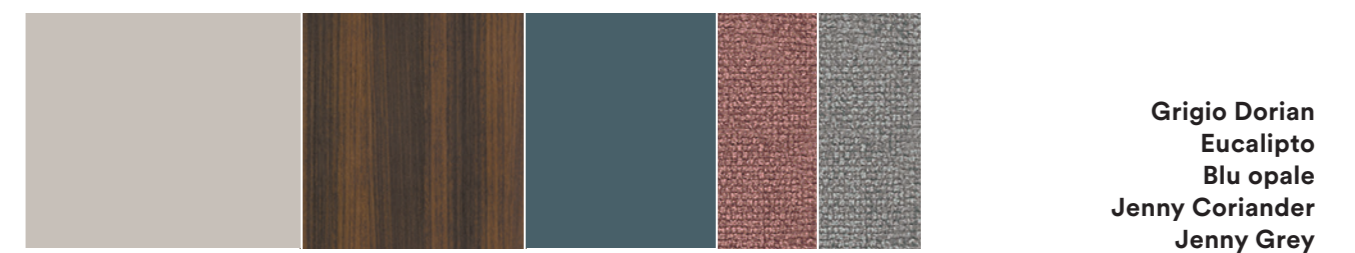

N11

IT
Armadio con anta battente
Cutting, letto Verso,
gruppo Leader.

EN
Wardrobe with Cutting
swing door, Verso bed,
Leader set.







LETTO VERSO | VERSO BED

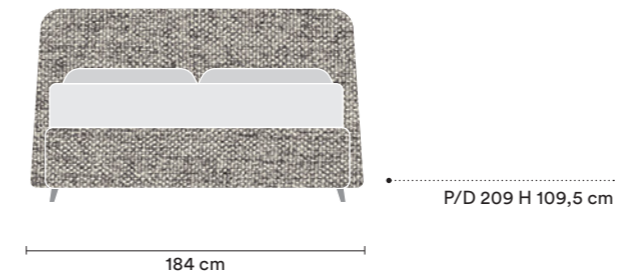

GRUPPO LEADER | LEADER SET

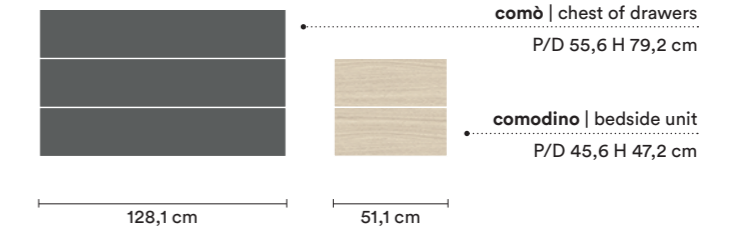

ARMADIO ANTA BATTENTE CUTTING | WARDROBE WITH CUTTING SWING DOOR

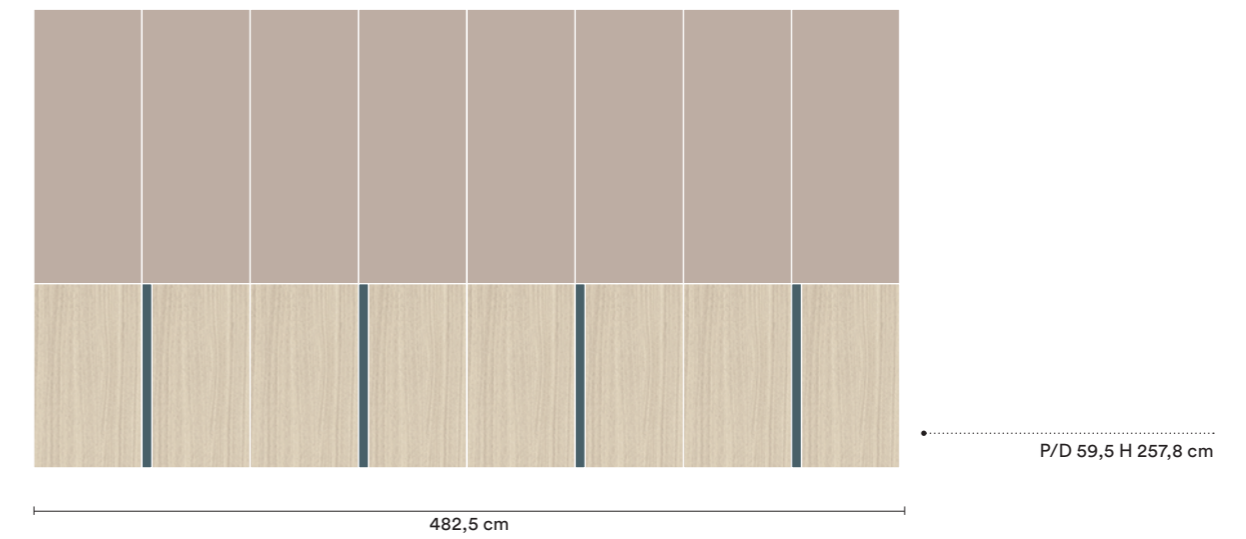

FINITURE | FINISHES

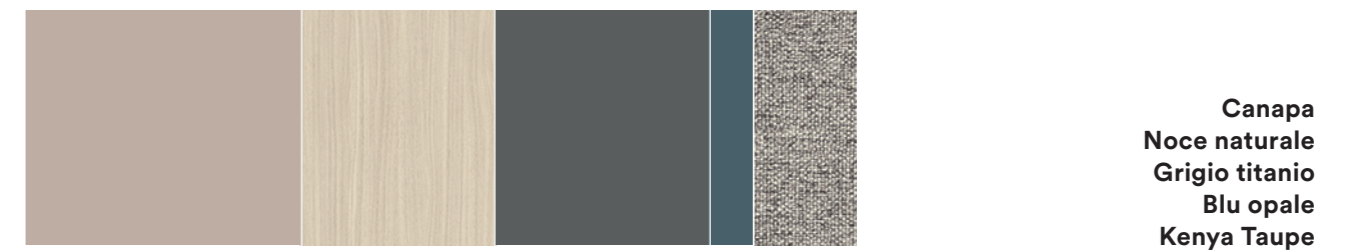

N12



IT
 Armadio con anta battente Cutting plus e vano porta tv, letto Adagio, gruppo Leader, piano Podio e basi sospese con anta Club, cabina armadio.

EN
 Wardrobe with Cutting plus swing door and TV housing space, Adagio bed, Leader set, Podio top and suspended base units with Club door, walk-in wardrobe.





LETTO ADAGIO | ADAGIO BED

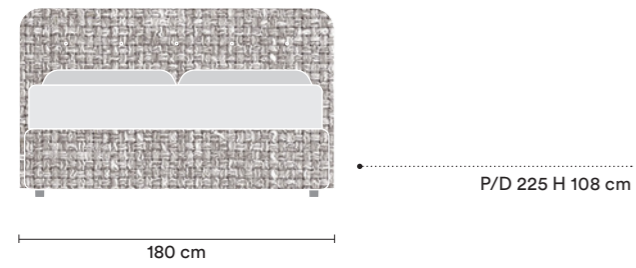

GRUPPO LEADER | LEADER SET

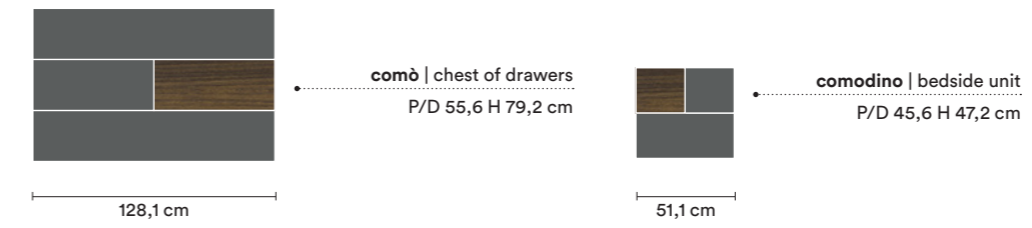

ARMADIO ANTA BATTENTE CUTTING PLUS | WARDROBE WITH CUTTING PLUS SWING DOOR

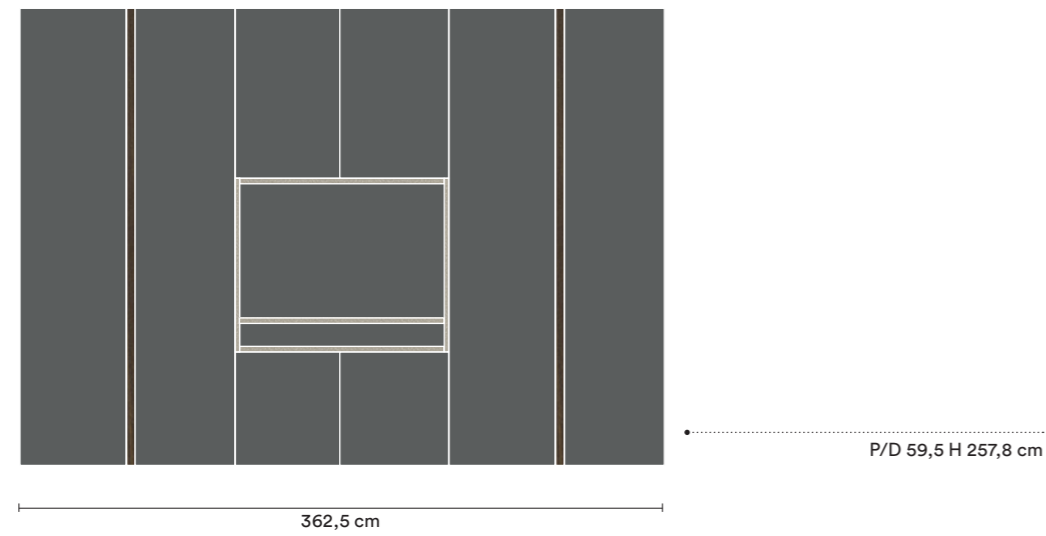

CABINA ARMADIO | WALK IN CLOSET

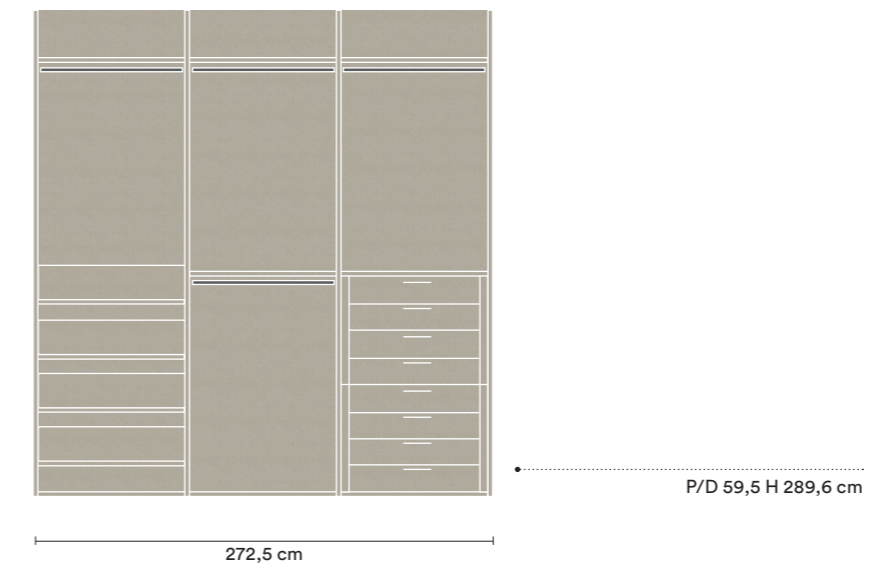

PIANO PODIO E BASI SOSPESSE | PODIO TOP AND SUSPENDED BASE UNITS

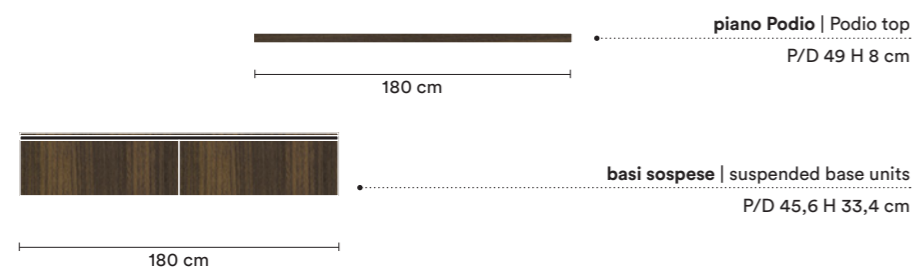

FINITURE | FINISHES

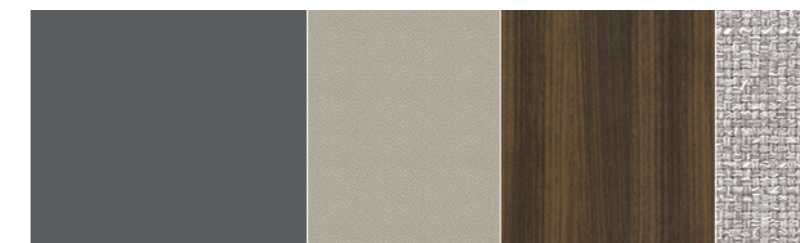

Grigio titanio
Leather Grey
Eucalipto
Ecochic Dorian

N13

IT
Armadio con anta scorrevole Mosaico, letto Time e gruppo Look.

EN
Wardrobe with Mosaico sliding door, Time bed and Look set.







LETTO TIME | TIME BED

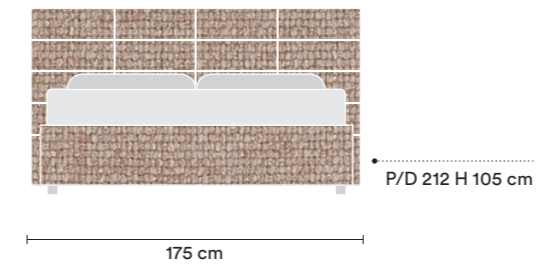

**ARMADIO ANTA SCORREVOLE MOSAICO
| WARDROBE WITH MOSAICO SLIDING DOOR**

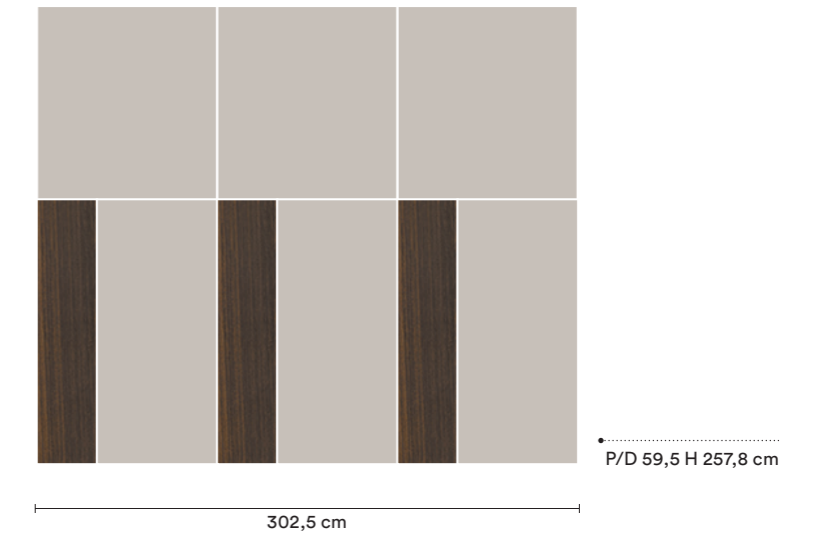

GRUPPO LOOK | LOOK SET

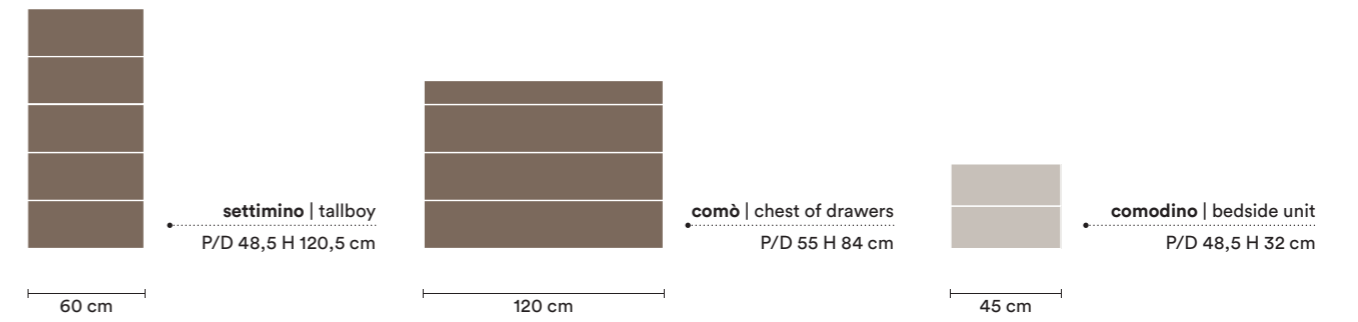

FINITURE | FINISHES

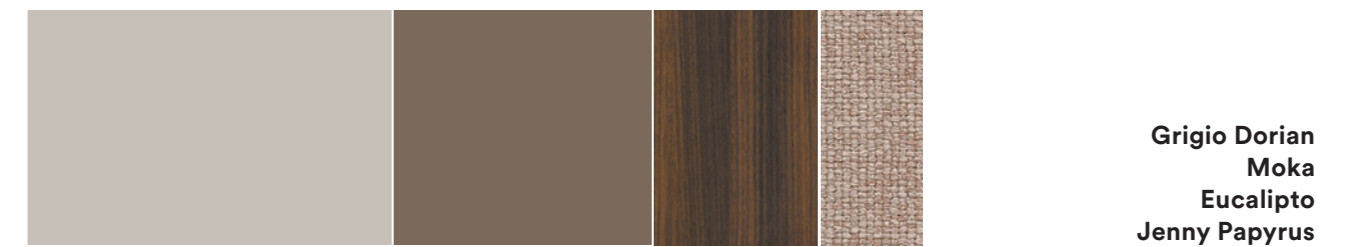

N14

IT
Armadio con anta scorrevole Mosaico, letto Adagio e gruppo Label.

EN
Wardrobe with Mosaico sliding door, Adagio bed and Label set.





LETTO ADAGIO | ADAGIO BED

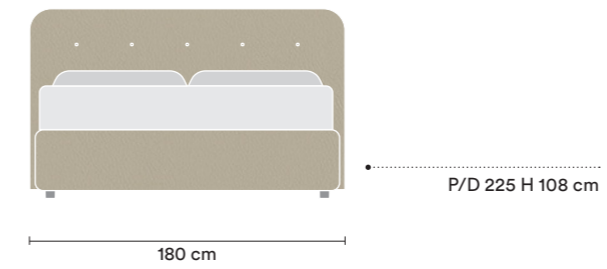

GRUPPO LABEL | LABEL SET

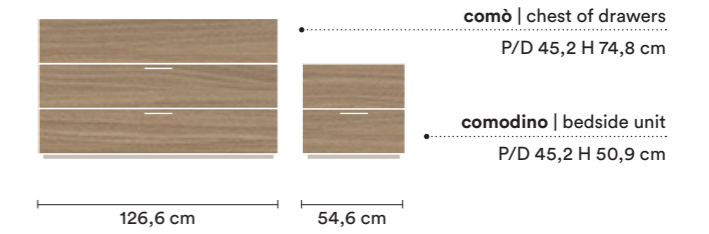

ARMADIO ANTA SCORREVOLE MOSAICO | WARDROBE WITH MOSAICO SLIDING DOOR

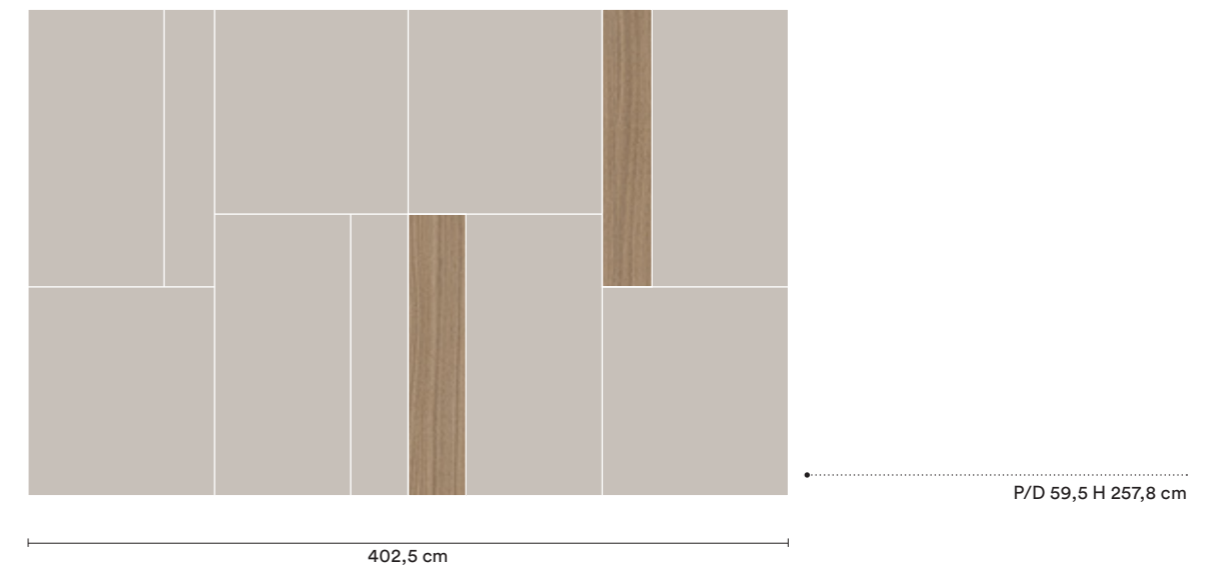

FINITURE | FINISHES



Grigio Dorian
Noce
Ecochic Travertino

N15

IT
Armadio con anta scorrevole Freedom, letto Tetris e gruppo Label.

EN
Wardrobe with Freedom sliding door, Tetris bed and Label set.





LETTO TETRIS | TETRIS BED

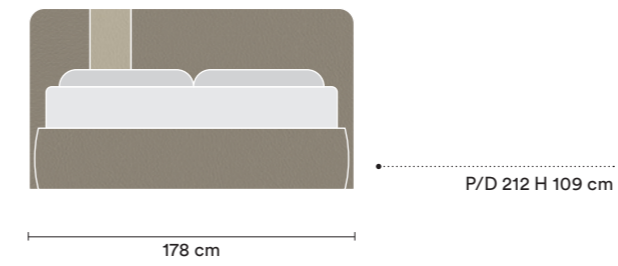

GRUPPO LABEL | LABEL SET

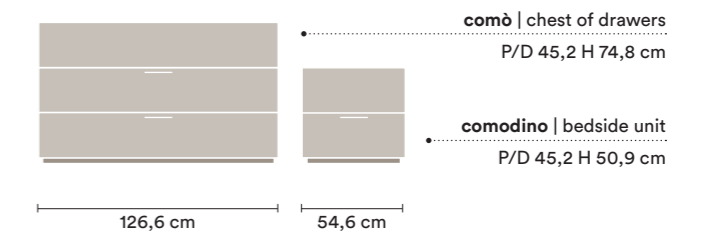

ARMADIO ANTA SCORREVOLE FREEDOM | WARDROBE WITH FREEDOM SLIDING DOOR

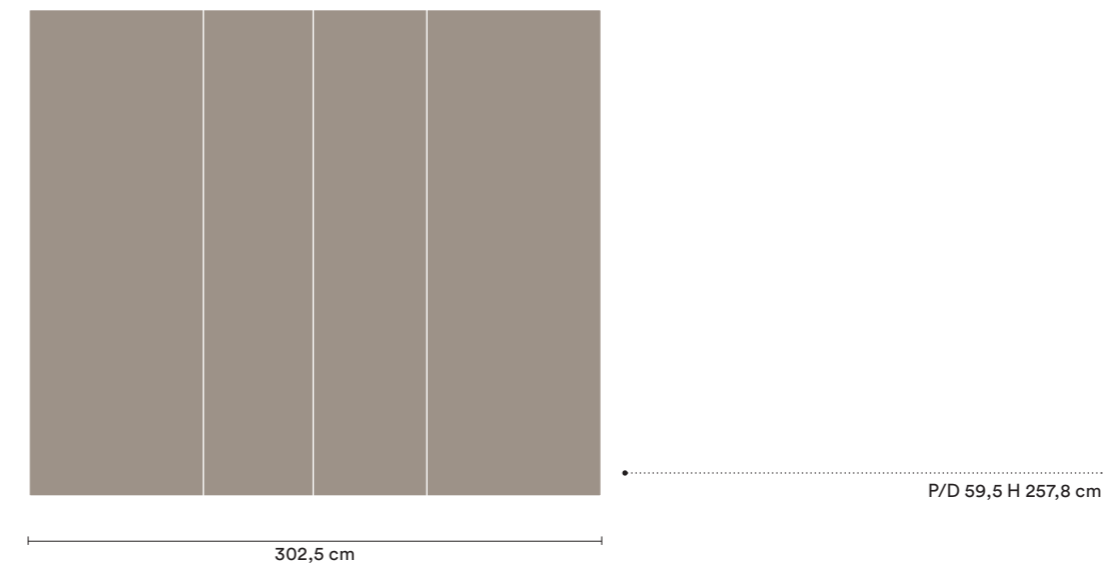

FINITURE | FINISHES



N16

IT
Armadio con anta scorrevole Mosaico, letto Kiss e gruppo Chic.

EN
Wardrobe with Mosaico sliding door, Kiss bed and Chic set.







LETTO KISS | KISS BED

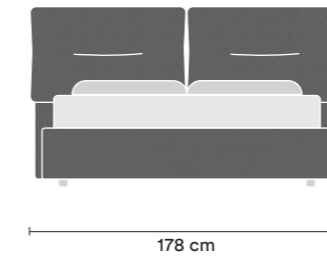

P/D 215 H 107 cm

GRUPPO CHIC | CHIC SET



comò | chest of drawers
P/D 54,5 H 74,7 cm

comodino | bedside unit
P/D 45 H 50,5 cm

ARMADIO ANTA SCORREVOLE MOSAICO | WARDROBE WITH MOSAICO SLIDING DOOR

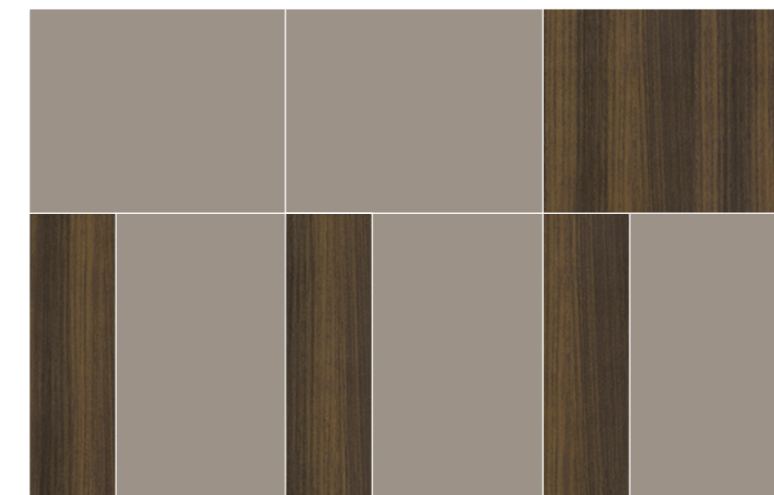

P/D 59,5 H 257,8 cm

FINITURE | FINISHES

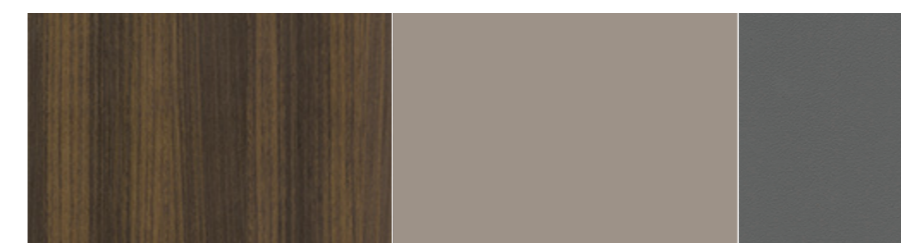

Eucalipto
Basalto
Ecochic Elephant

N17

IT
Armadio con anta scorrevole Freedom, letto Sector con giroletto Marte e gruppo Chic.

EN
Wardrobe with Freedom sliding door, Sector bed with Marte bed frame and Chic set.







LETTO SECTOR | SECTOR BED

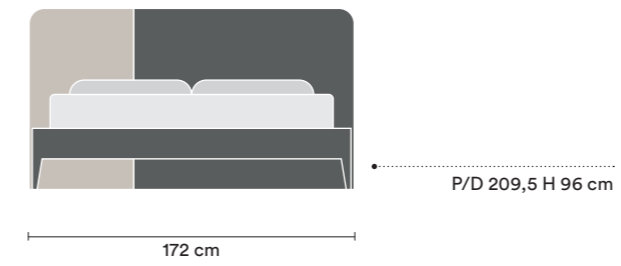

GRUPPO CHIC | CHIC SET

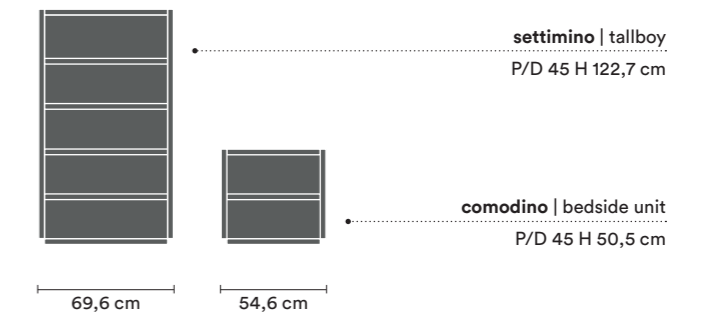

ARMADIO ANTA SCORREVOLE FREEDOM | WARDROBE WITH FREEDOM SLIDING DOOR

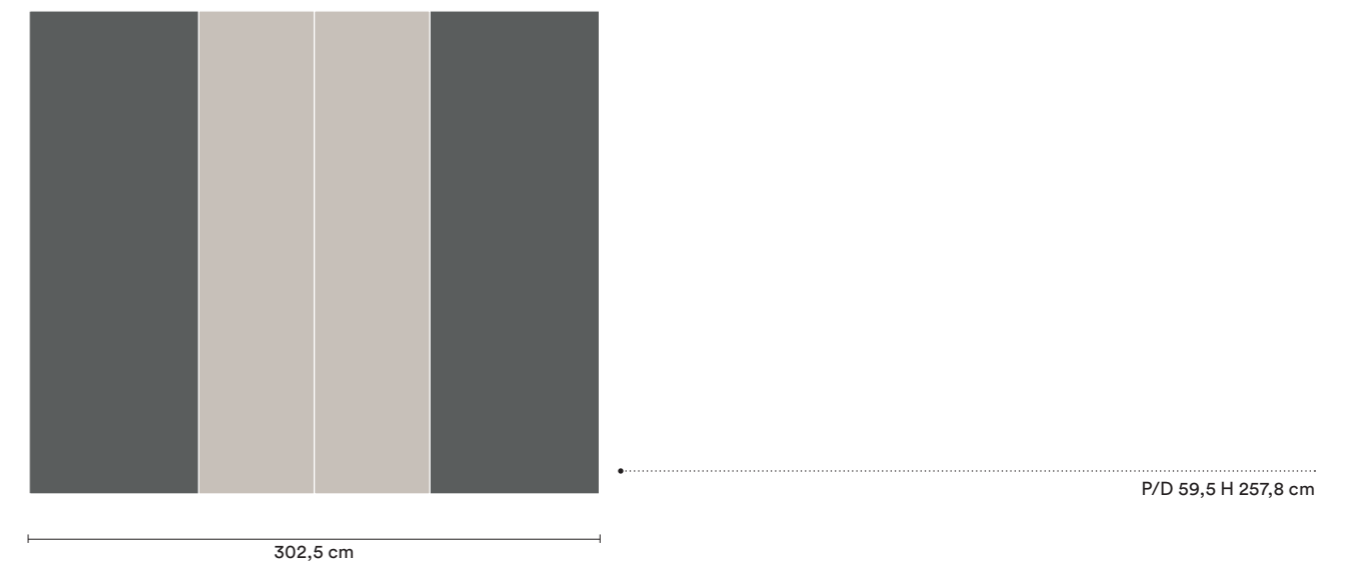

FINITURE | FINISHES



N18

IT
Armadio con anta scorrevole
Rail, letto Adagio e gruppo
Bold su piedini Nume.

EN
Wardrobe with Rail sliding
door, Adagio bed and Bold set
on Nume feet.





LETTO ADAGIO | ADAGIO BED

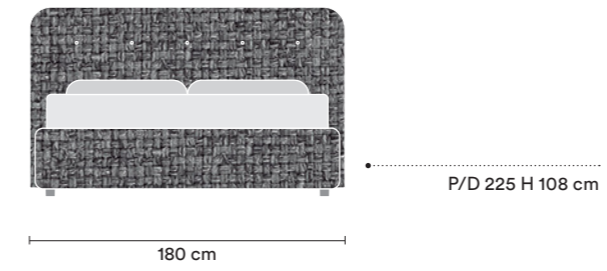

GRUPPO BOLD | BOLD SET

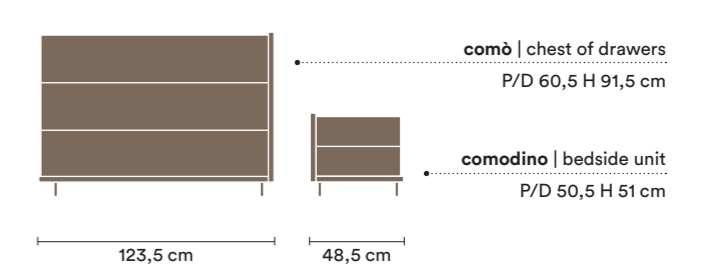

ARMADIO ANTA SCORREVOLE RAIL | WARDROBE WITH RAIL SLIDING DOOR

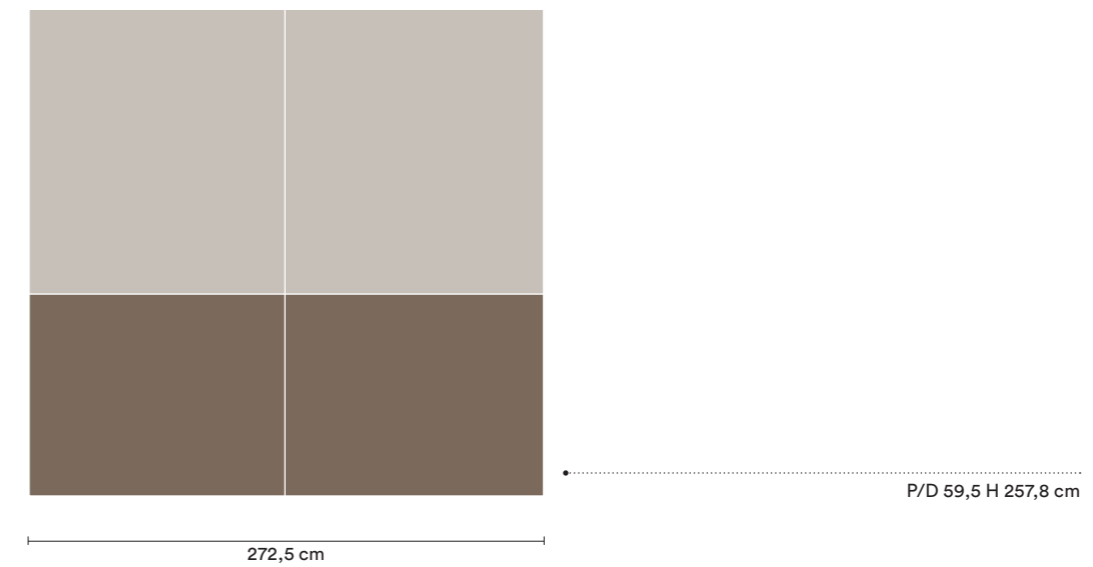

FINITURE | FINISHES

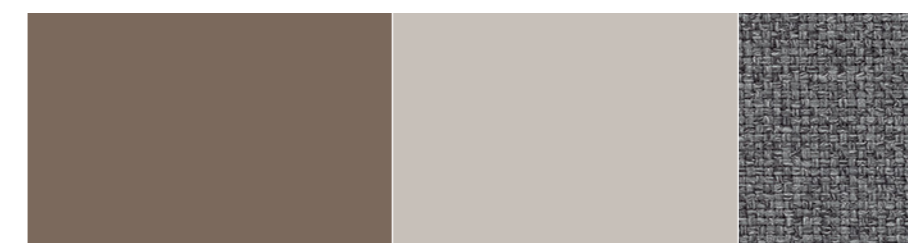

Moka
Grigio Dorian
Ecochic Titanio

N19

IT
 Armadio con anta battente One
 e maniglia Bul, nicchia, ponte Rialto
 e scrivania Podio, letto Cushy con
 alloggiamento posteriore e giroletto
Nettuno, gruppo Brick e panchetta Podio.

EN
 Wardrobe with One swing door and
Bul handle, niche, Rialto overhead
 wardrobe and Podio desk, Cushy bed
 with rear compartment and Nettuno
 bed frame, Brick set and Podio bench.







LETTO CUSHY | CUSHY BED

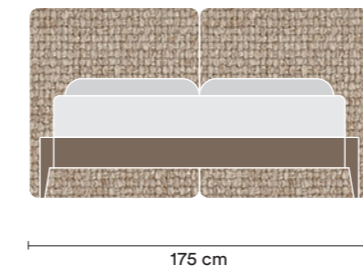

GRUPPO BRICK | BRICK SET

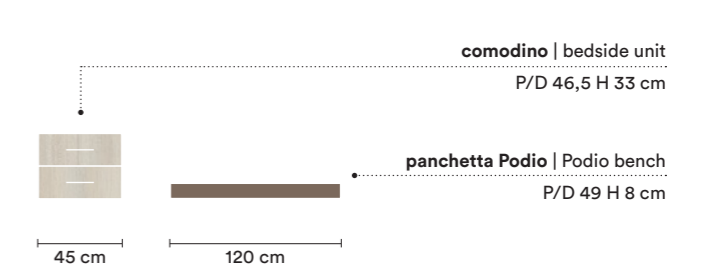

ARMADIO ANTA BATTENTE ONE | WARDROBE WITH ONE SWING DOOR



FINITURE | FINISHES



Ciliegio bianco
Moka
Jenny Papyrus

N20

Armadi nicchiati esaltano la zona notte rendendola protagonista assoluta. Tessili imbottiti valorizzano il pregio. Forme essenziali e tonalità tenui esprimono un'eleganza moderna, accogliente e delicata.

Niche wardrobes enhance the bedroom, making it the absolute protagonist. Upholstered textiles heighten their value. Understated forms and soft hues express modern, welcoming and gentle elegance.

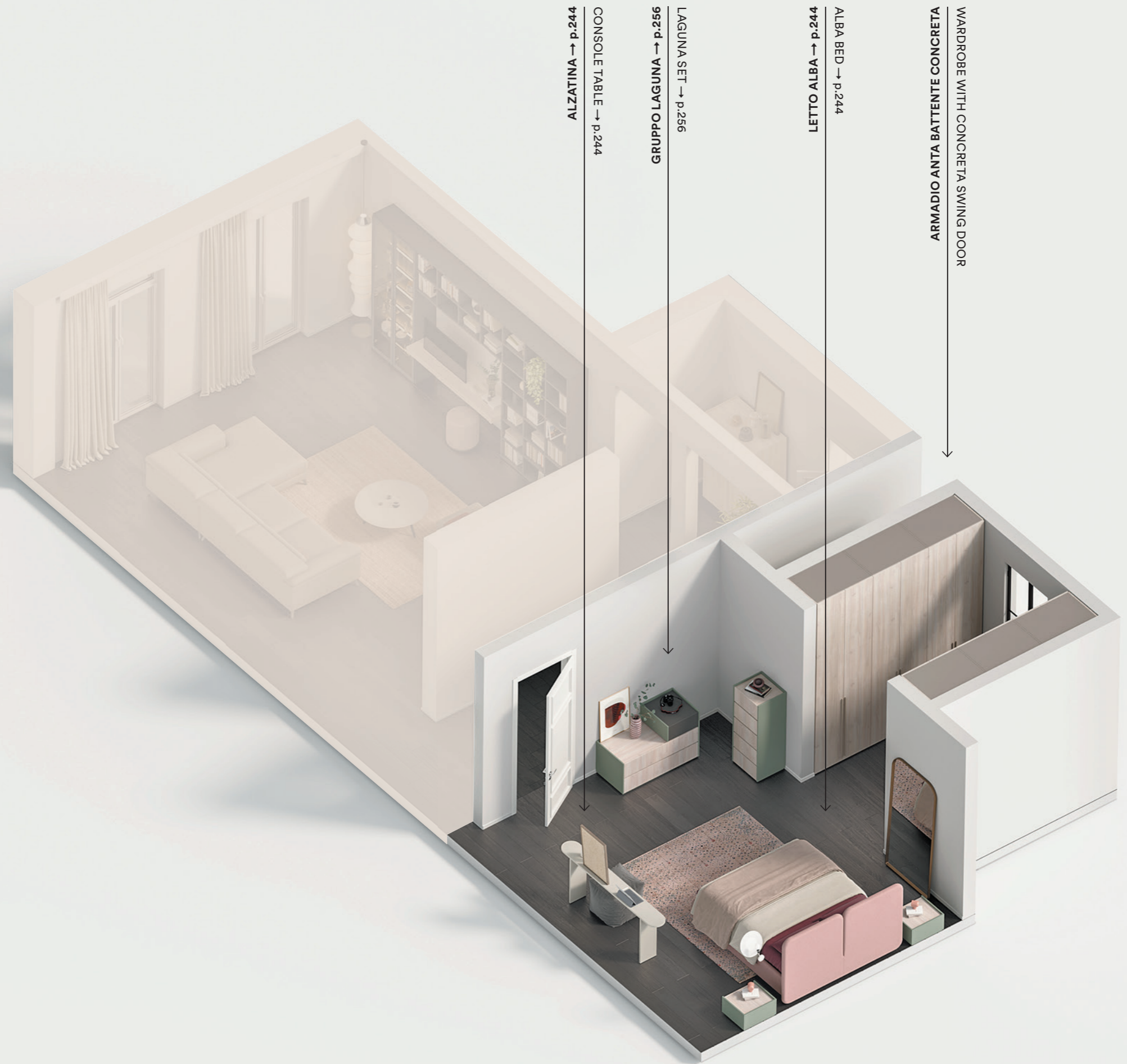

SCOPRI LE ALTRE COMPOSIZIONI → p.148

SEE THE OTHER COMPOSITIONS → p.148



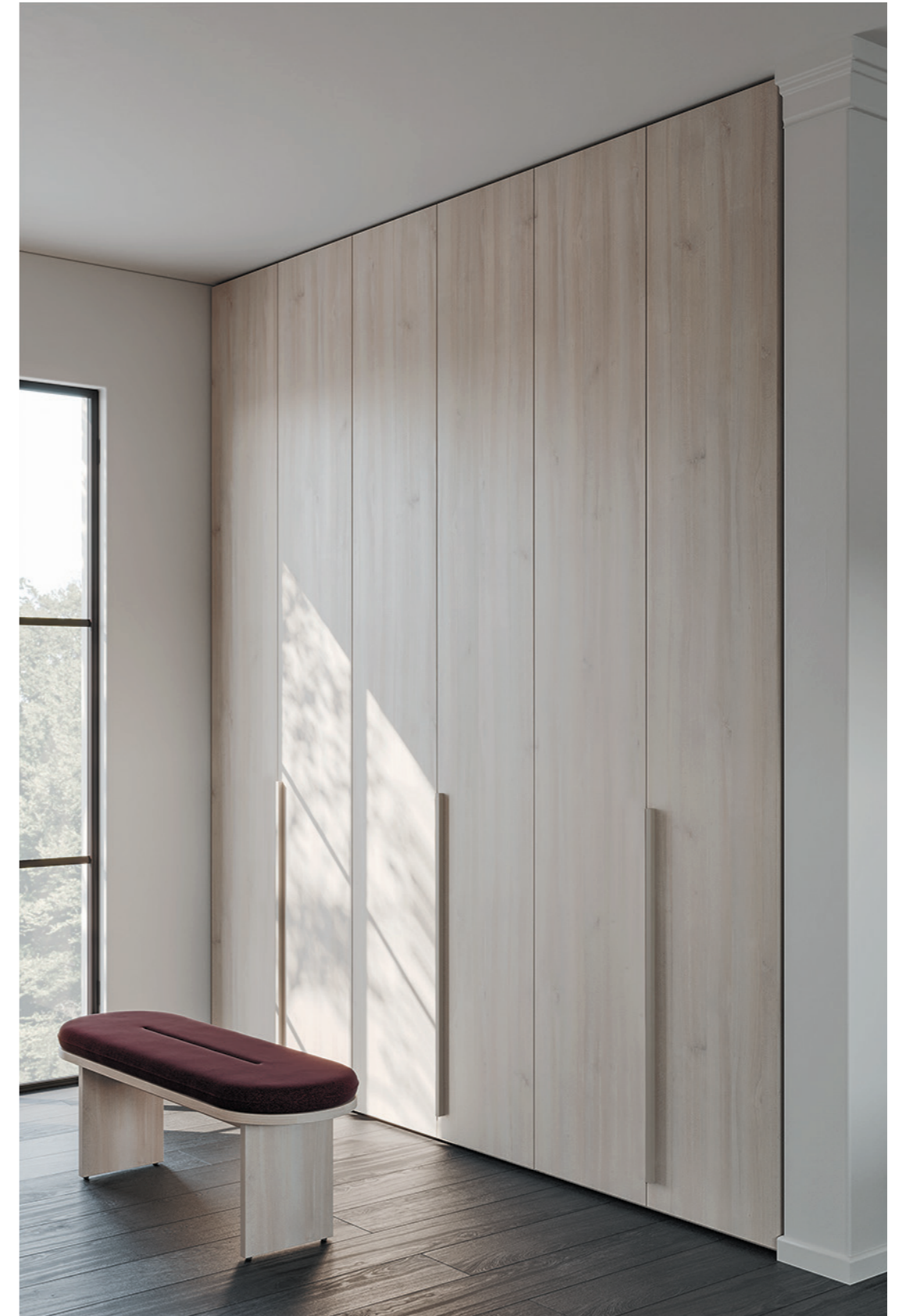
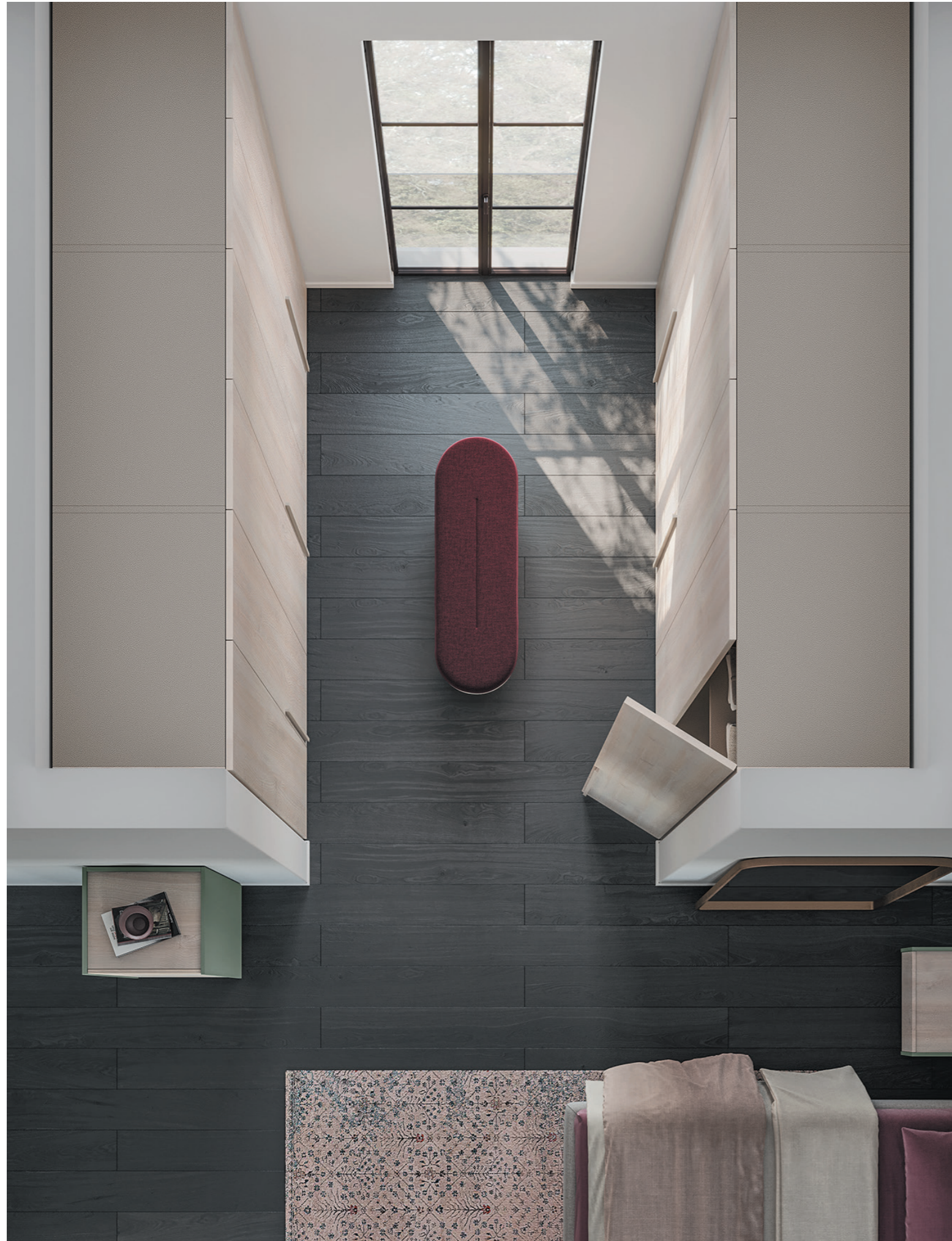



IT
Armadio con anta battente Concreta e maniglia Pul, letto Alba, alzatina e panca fondo letto, gruppo Laguna.

EN
Wardrobe with Concreta swing door and Pul handle, Alba bed, console table and end-of-bed bench, Laguna set.



LETTO ALBA | ALBA BED

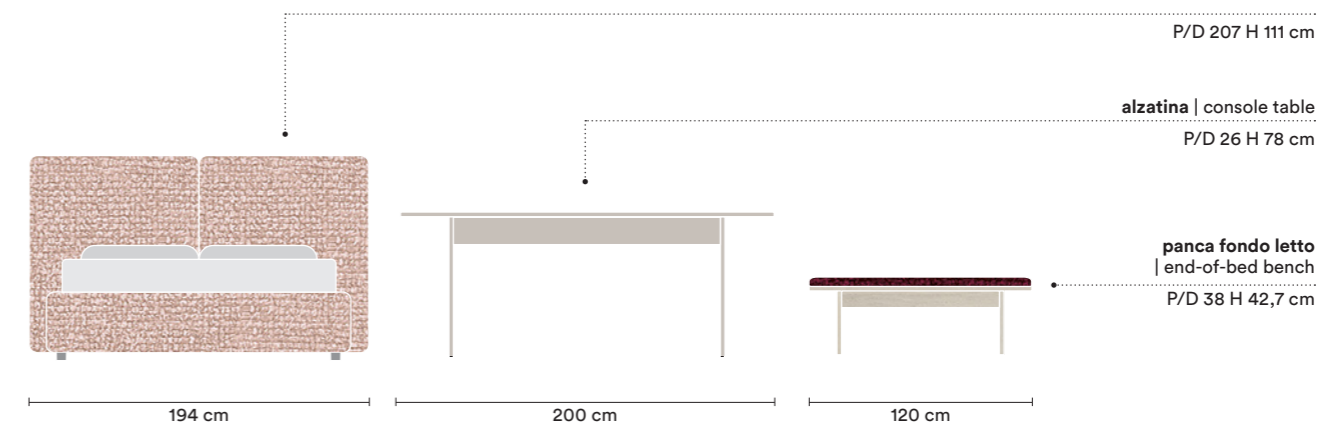

**ARMADIO ANTA BATTENTE CONCRETA
| WARDROBE WITH CONCRETA SWING DOOR**

GRUPPO LAGUNA | LAGUNA SET



FINITURE | FINISHES

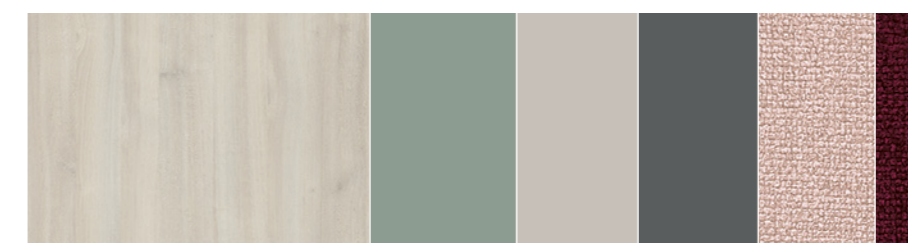

- Ciliegio bianco
- Agave
- Grigio Dorian
- Grigio titanio
- Jenny Pill
- Jenny Bombay

N21

IT
 Armadio con anta battente
Concreta, cabina e maniglia Pul,
 letto Twin e componibili sospesi,
 gruppo Quadro.

EN
 Wardrobe with Concreta swing
 door, walk-in and Pul handle,
Twin bed and suspended
 modular elements, Quadro set.







LETTO TWIN | TWIN BED

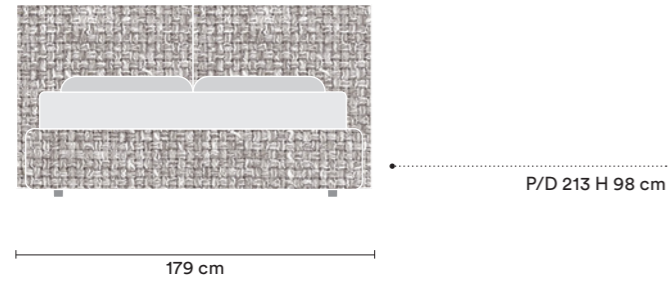

GRUPPO QUADRO | QUADRO SET

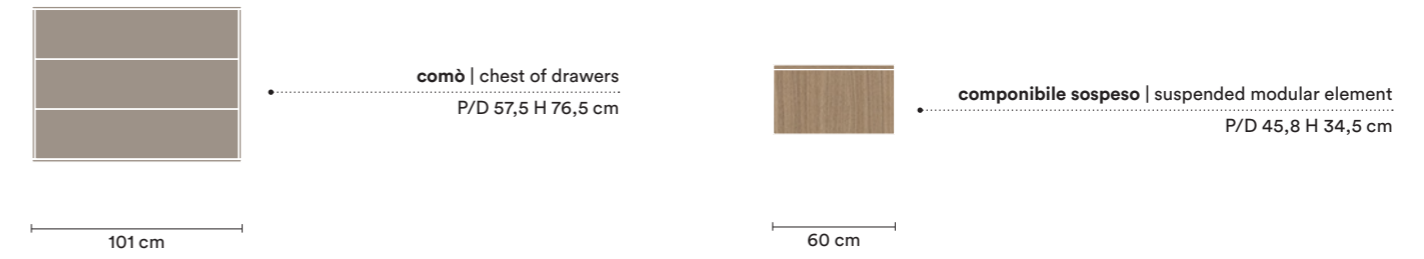

**ARMADIO ANTA BATTENTE CONCRETA E CABINA ARMADIO
| WARDROBE WITH CONCRETA SWING DOOR AND WALK-IN**

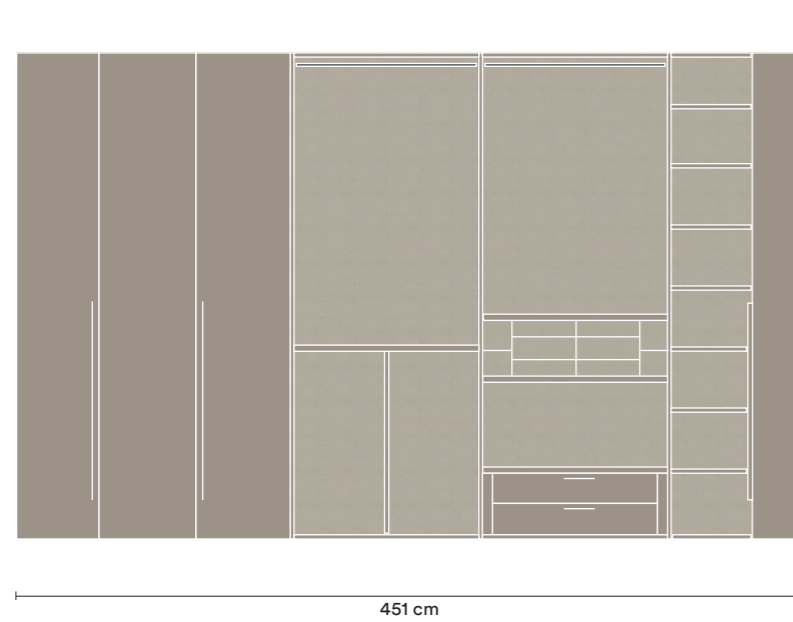

**CABINA ARMADIO E ARMADIO ANTA BATTENTE CONCRETA
| WALK-IN AND WARDROBE WITH CONCRETA SWING DOOR**

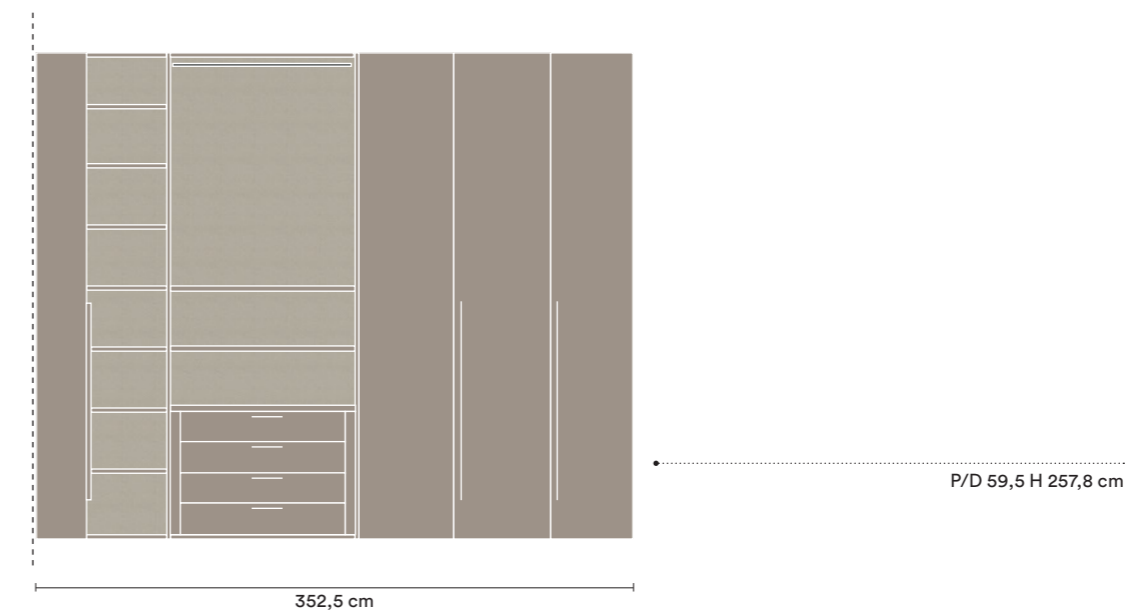

FINITURE | FINISHES



Basalto
Leather grey
Noce
Ecochic Dorian

N22

IT
 Armadio con anta scorrevole Concreta e maniglia Pul, letto Snug, gruppo Label e panca fondo letto.

EN
 Wardrobe with Concreta sliding door and Pul handle, Snug bed, Label set and end-of-bed bench.







LETTO SNUG | SNUG BED

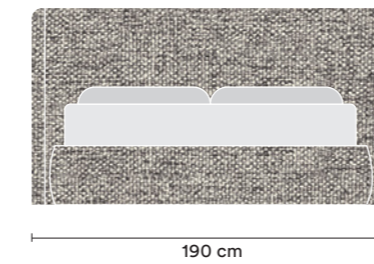

GRUPPO LABEL | LABEL SET

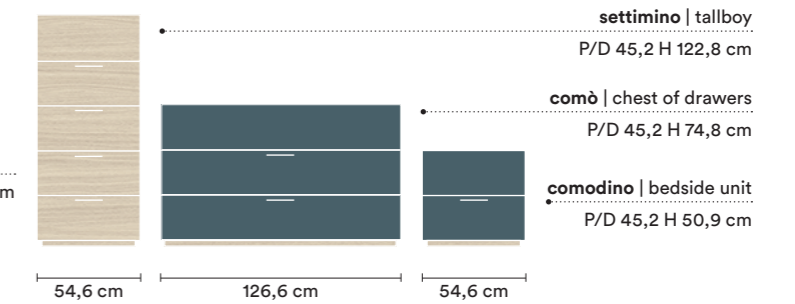

ARMADIO ANTA SCORREVOLE CONCRETA | WARDROBE WITH CONCRETA SLIDING DOOR

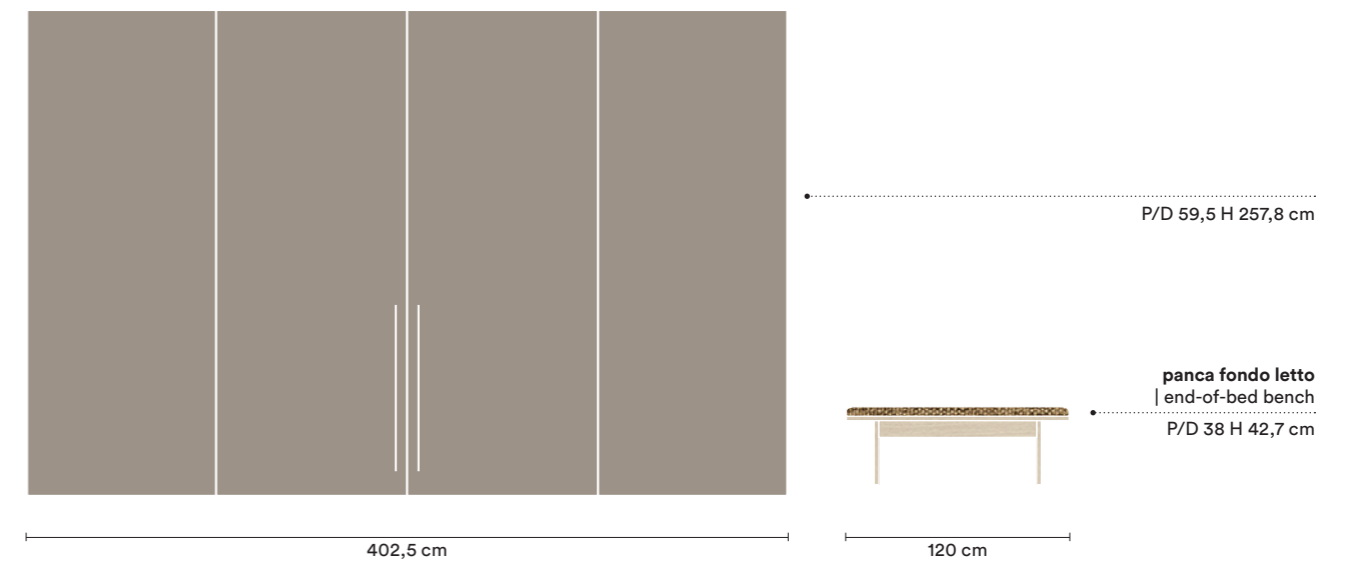

FINITURE | FINISHES



Basalto
Blu opale
Noce naturale
Kenya Taupe
Kenya Camel

N23

IT
 Armadio con anta battente Concreta,
 nicchia e maniglia Ines, armadio per
 passaggio, letto Unique, gruppo Leader,
 piano Podio e mensole.

EN
 Wardrobe with Concreta swing door,
 niche and Ines handle, over-door
 wardrobe, Unique bed, Leader set,
Podio top and shelves.







LETTO UNIQUE | UNIQUE BED

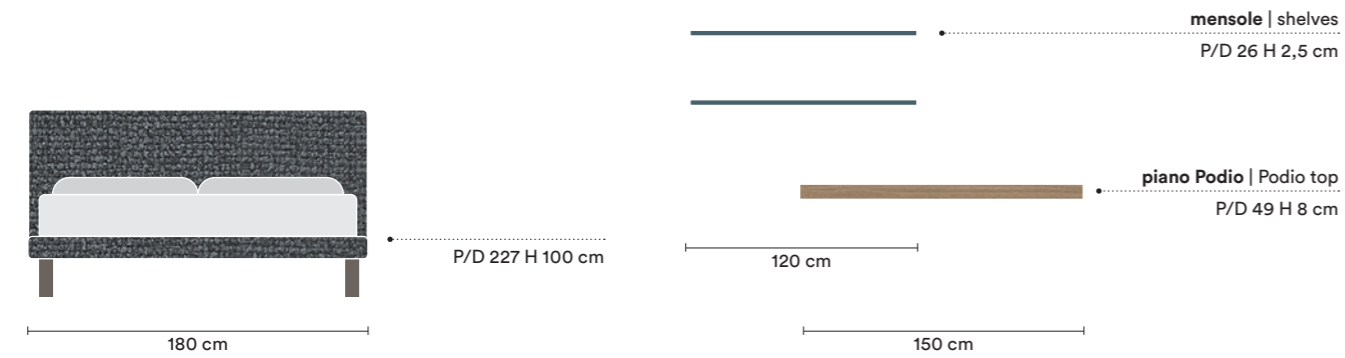

GRUPPO LEADER | LEADER SET

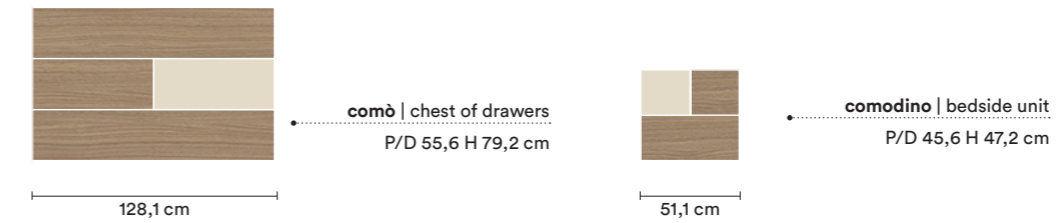

ARMADIO ANTA BATTENTE CONCRETA | WARDROBE WITH CONCRETA SWING DOOR

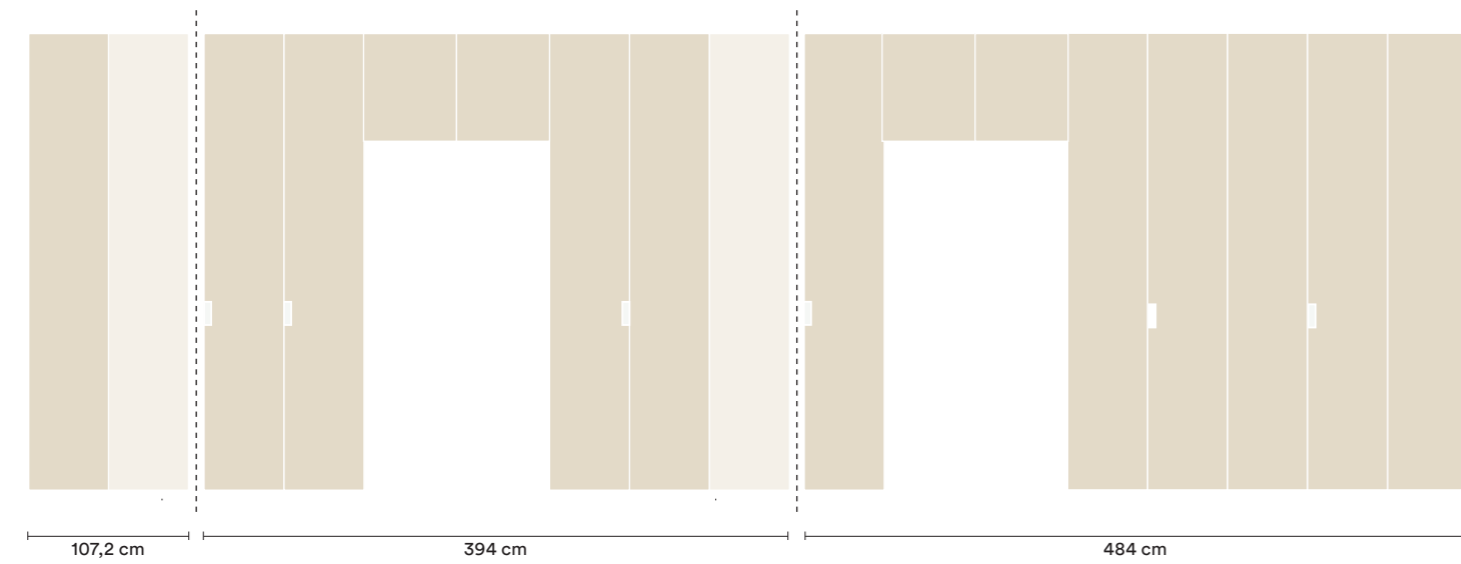

ARMADIO ANTA BATTENTE CONCRETA CON NICCHIA | WARDROBE WITH CONCRETA SWING DOOR AND NICHE

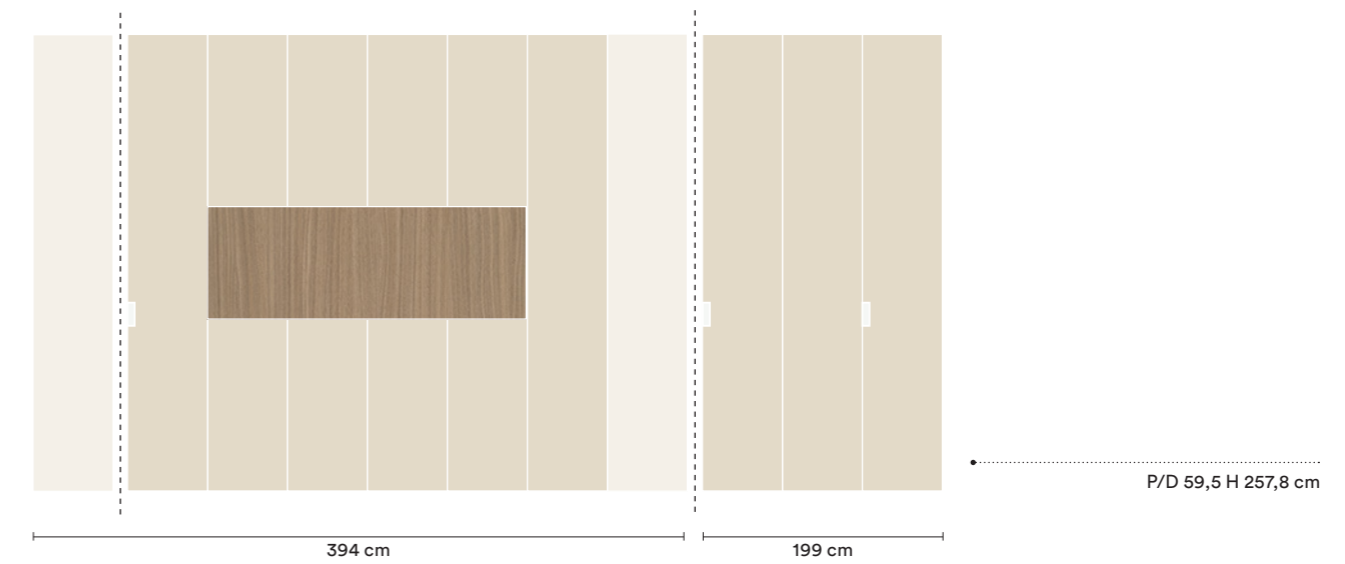

FINITURE | FINISHES



Desert
Noce
Blu opale
Jenny Smoke

N24

IT
 Armadio battente con anta Club.
 Letto Mushy con alloggiamento
 posteriore e giroletto Marte.
 Gruppo Bold su piedini Nume.

EN
 Swing wardrobe with Club
 door. Mushy bed with rear
 compartment and Marte bed
 frame. Bold set on Nume feet.







LETTO MUSHY | MUSHY BED

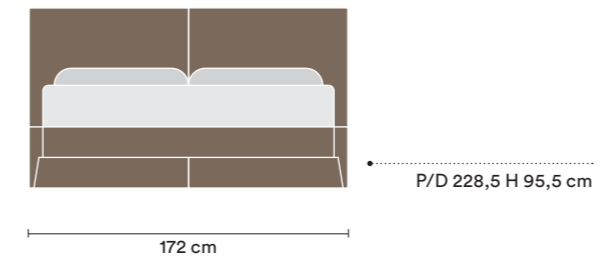

GRUPPO BOLD | BOLD SET

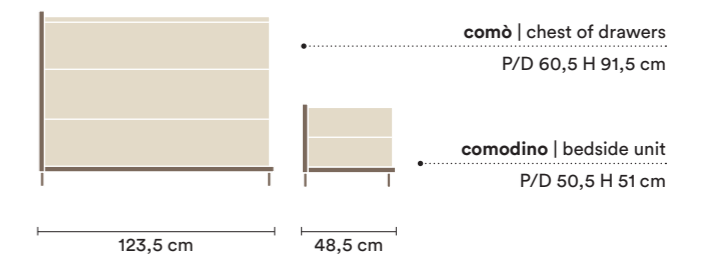

ARMADIO ANTA BATTENTE CLUB | WARDROBE WITH CLUB SWING DOOR

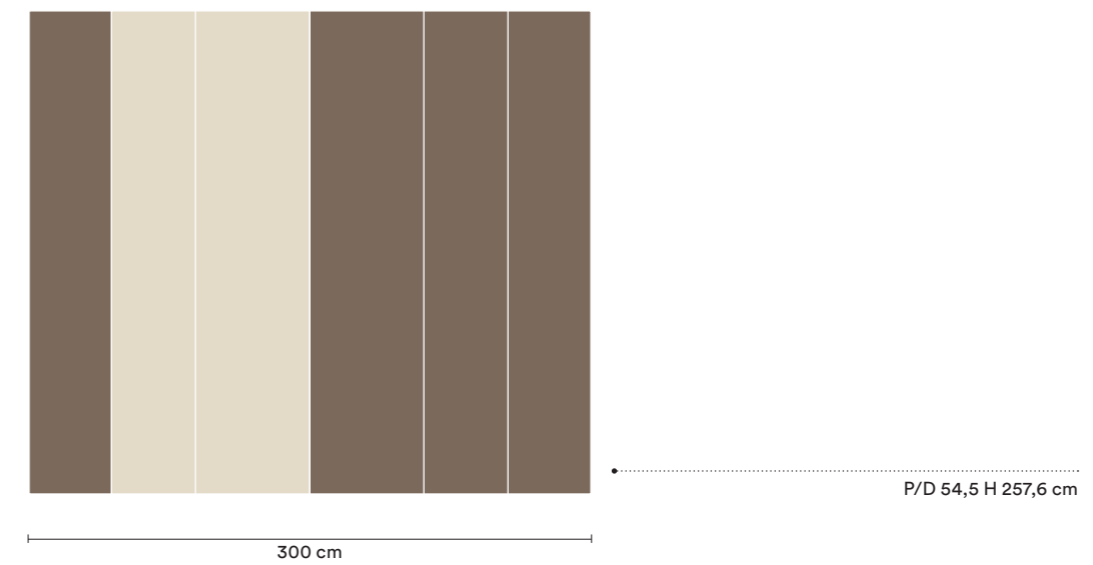

FINITURE | FINISHES



**Moka
Desert**

N25

IT
Armadio con anta battente
Concreta e consolle,
letto Virgo con giroletto
Marte, gruppo Label.

EN
Wardrobe with Concreta
swing door and console,
Virgo bed with Marte
bed frame, Label set.







LETTO VIRGO | VIRGO BED

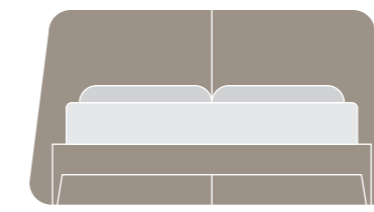

P/D 209,5 H 100 cm

177,5 cm

GRUPPO LABEL | LABEL SET



comò | chest of drawers
P/D 45,2 H 74,8 cm

comodino | bedside unit
P/D 45,2 H 50,9 cm

126,6 cm

54,6 cm

ARMADIO ANTA BATTENTE CONCRETA CON CONSOLLE
| WARDROBE WITH CONCRETA SWING DOOR AND CONSOLE

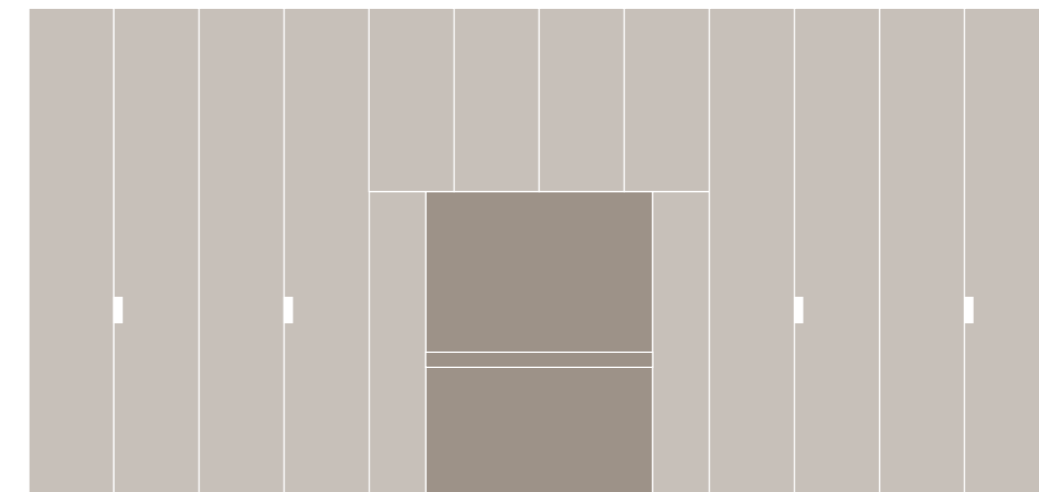

P/D 59,5 H 257,8 cm

543 cm

FINITURE | FINISHES



Grigio Dorian
Basalto

N26

IT
 Armadio con anta battente One,
 maniglia Bul e cassetti Club, letto
Sector con giroletto Marte
 e gruppo Brick con pomello Pin.

EN
 Wardrobe with One swing door,
Bul handle and Club drawers,
Sector bed with Marte bed frame
 and Brick set with Pin knob.







LETTO SECTOR | SECTOR BED

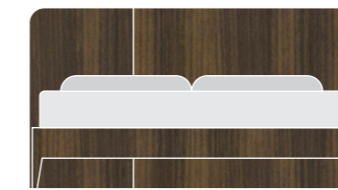

172 cm

P/D 210 H 96 cm

GRUPPO BRICK | GRUPPO BRICK

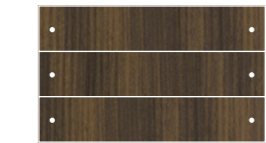

120 cm



45 cm

comò | chest of drawers
P/D 57 H 73 cm

comodino | bedside unit
P/D 46,5 H 33 cm

ARMADIO ANTA BATTENTE ONE CON CASSETTI CLUB
| WARDROBE WITH ONE SWING DOOR AND CLUB DRAWERS

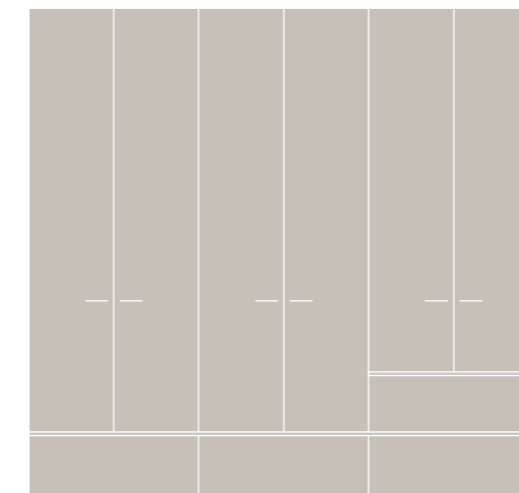

270 cm

P/D 54,5 H 257,6 cm

FINITURE | FINISHES

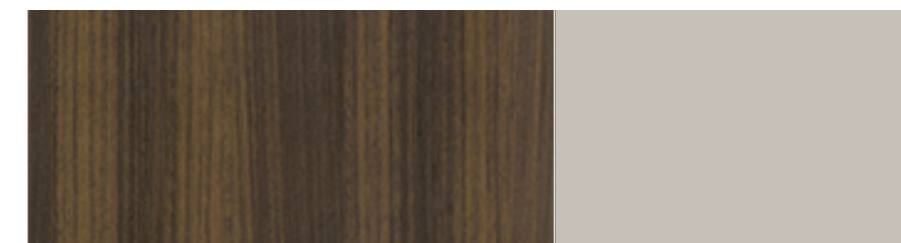

Eucalipto
Grigio Dorian

N27

IT
 Armadio con anta battente One, nicchie e pomello Pin,
 letto Reverso con piedini
 in plexiglass e gruppo Gape
 su piedini Epsilon.

EN
 Wardrobe with One swing
 door, niches and Pin knob,
Reverso bed with plexiglass feet
 and Gape set on Epsilon feet.





Variante compositiva | Composition variant

IT
Armadio con anta battente **One** e maniglia **Bul**, nicchia e modulo porta tv.

EN
Wardrobe with **One** swing door and **Bul** handle, niche and TV panel module.



LETTO REVERSO | REVERSO BED

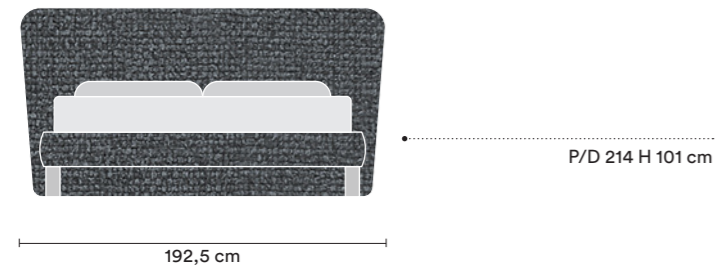

GRUPPO GAPE | GAPE SET

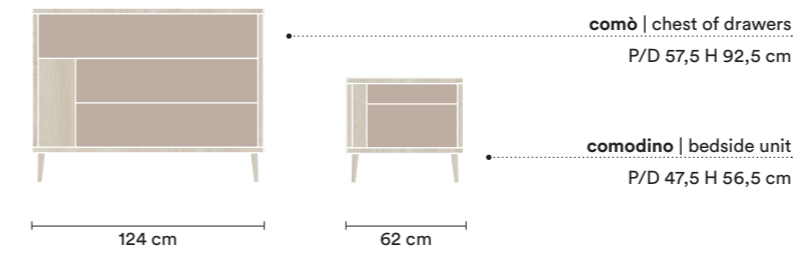

**ARMADIO ANTA BATTENTE ONE CON NICCHIE
| WARDROBE WITH ONE SWING DOOR AND NICHE**

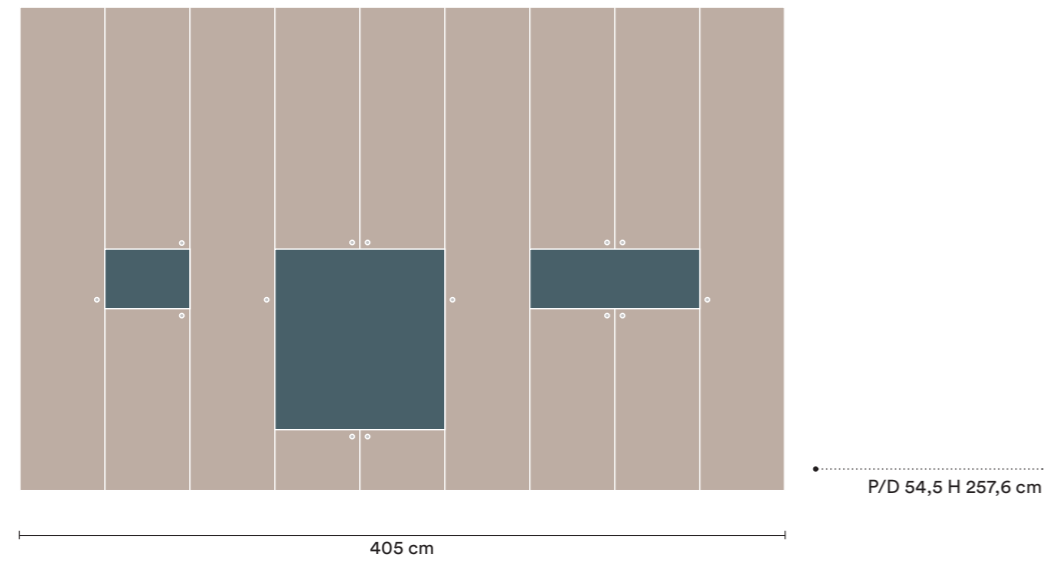

**ARMADIO ANTA BATTENTE ONE CON NICCHIE E PORTA TV
| WARDROBE WITH ONE SWING DOOR, NICHE AND TV PANEL MODULE**

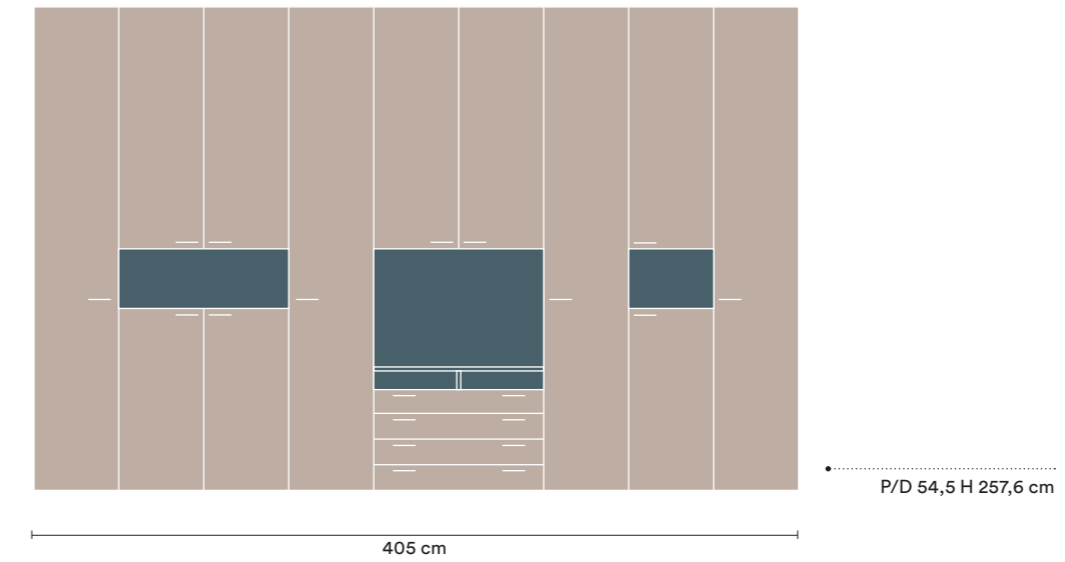

FINITURE | FINISHES



Canapa
Blu opale
Ciliegio bianco
Jenny Smoke

N28

Una camera di dimensioni esigue: la libreria che separa, ritma e di nuovo connette. Dal letto all'armadio agli altri componenti di arredo: la creatività orchestra lo spazio con uno stile essenziale.

A modest-sized bedroom: the bookshelf that separates, adds rhythm and then reconnects. From the bed to the wardrobe to all the other furnishings: creativity orchestrates the space in essential style.



SCOPRI LE ALTRE COMPOSIZIONI → p.208

SEE THE OTHER COMPOSITIONS → p.208



IT

Libreria Infinity a terra in contropinta con porta tv girevole e anta battente One, armadio con anta battente Concreta e maniglia Ines, letto Line, gruppo Look.

EN

Infinity floor-standing counter-opposing bookshelf with swivel TV stand and One swing door, wardrobe with Concreta swing door and Ines handle, Line bed, Look set.





LETTO LINE | LINE BED

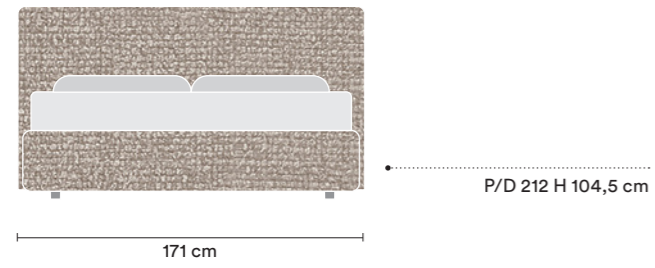

GRUPPO LOOK | LOOK SET

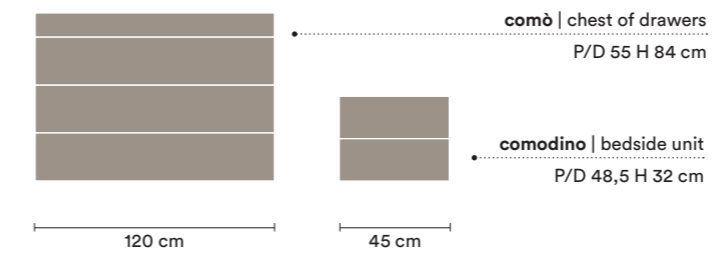

ARMADIO ANTA BATTENTE CONCRETA | WARDROBE WITH CONCRETA SWING DOOR

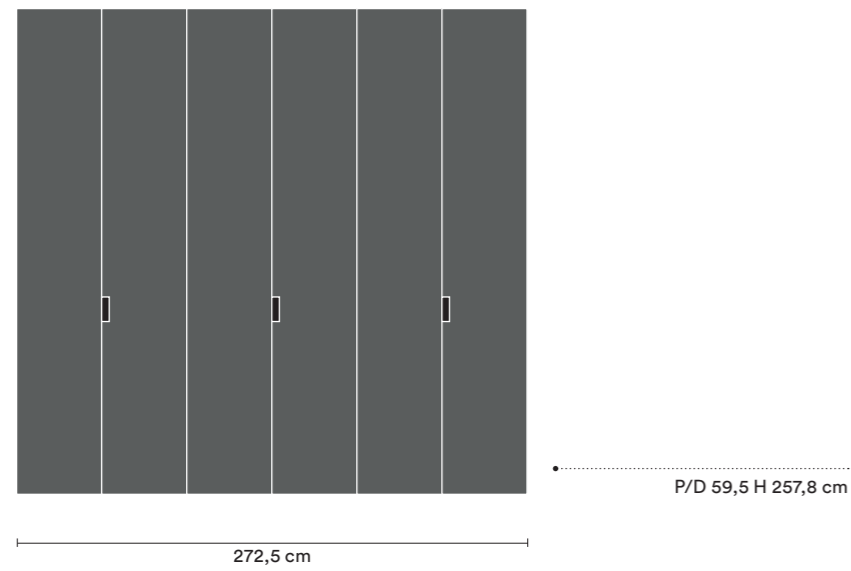

LIBRERIA INIFINITY | INFINITY BOOKSHELF

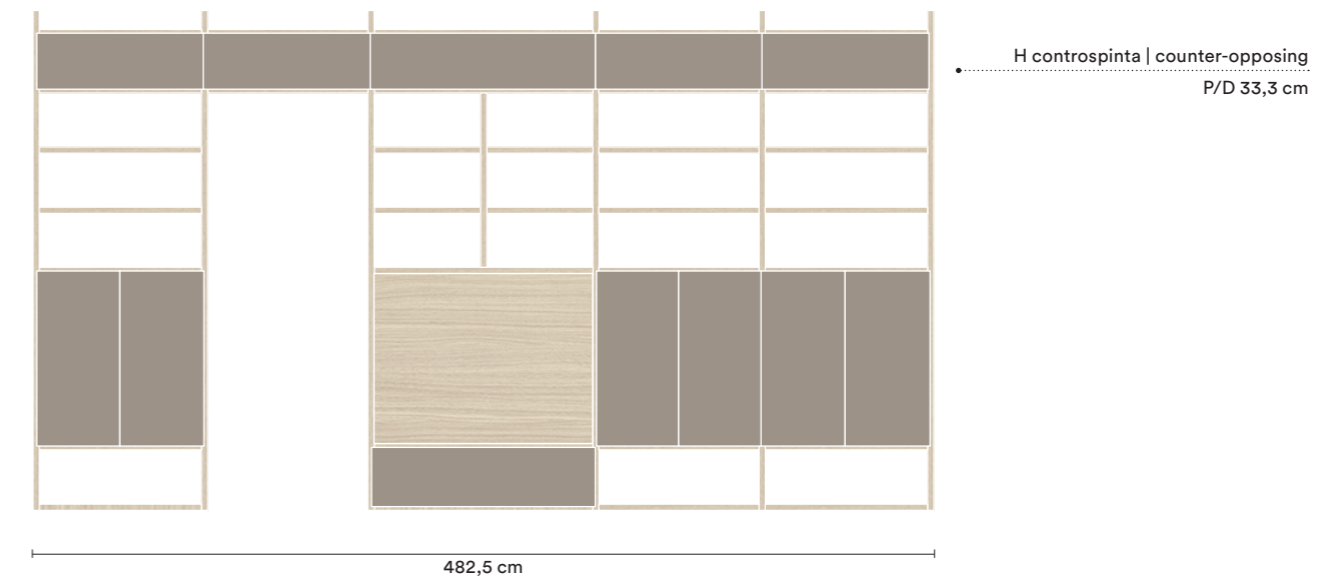

FINITURE | FINISHES



Basalto
Grigio titanio
Noce naturale
Jenny Zinc

N29



IT
 Armadio con anta scorrevole Cutting, letto Verso con piedini Delta, gruppo Brick con maniglia Bul.

EN
 Wardrobe with Cutting sliding door, Verso bed with Delta feet, Brick set with Bul handle.





LETTO VERSO | VERSO BED

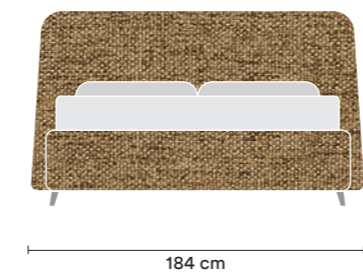

GRUPPO BRICK | BRICK SET

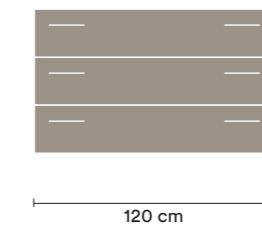

comò | chest of drawers
P/D 57 H 73 cm

comodino | bedside unit
P/D 46,5 H 33 cm

ARMADIO ANTA SCORREVOLE CUTTING | WARDROBE WITH CUTTING SLIDING DOOR

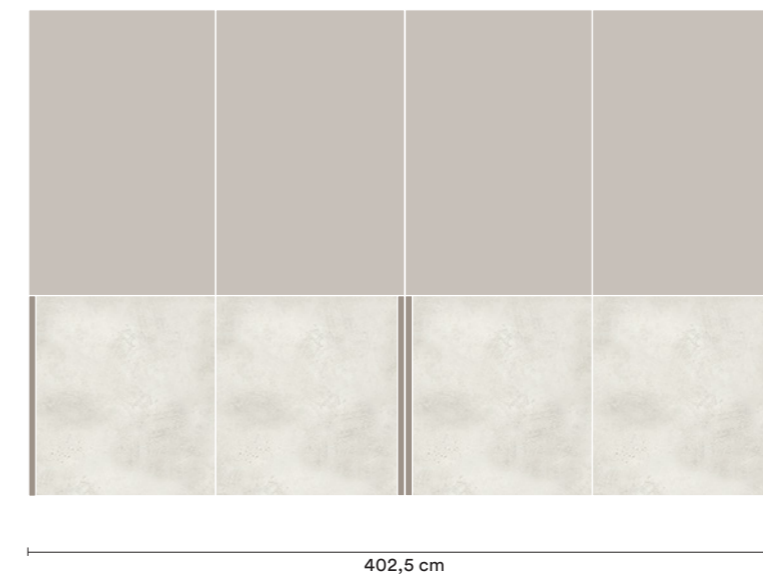

FINITURE | FINISHES

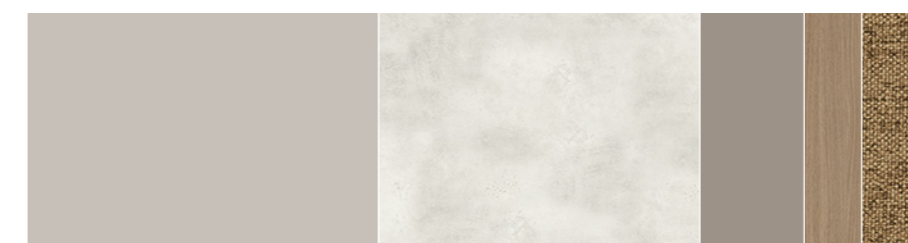

Grigio Dorian
Malta
Basalto
Noce
Kenya Camel

N30



IT
Armadio con anta battente Cutting, ponte, letto Virgo con giroletto Atlante e gruppo Quadro.

EN
Wardrobe with Cutting swing door, overhead, Virgo bed with Atlante bed frame and Quadro set.





LETTO VIRGO | VIRGO BED

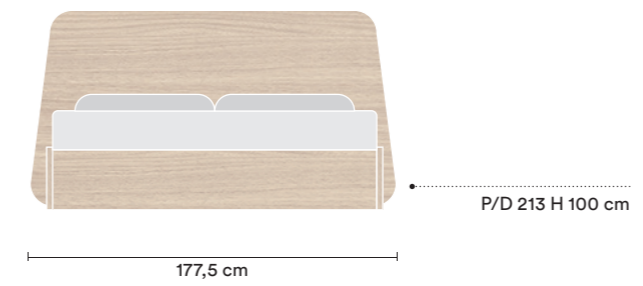

GRUPPO QUADRO | QUADRO SET

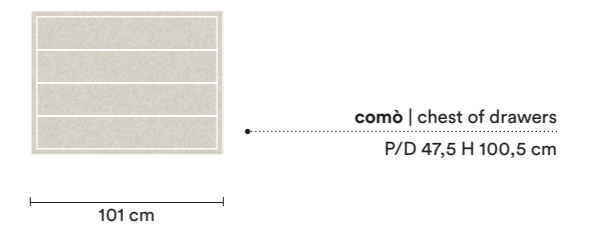

ARMADIO ANTA BATTENTE CUTTING | WARDROBE WITH CUTTING SWING DOOR



FINITURE | FINISHES



N31

IT
 Armadio con anta battente Club
 e terminale Quid, letto Narciso
 con piedini Delta, gruppo Look
 su piedini Epsilon e libreria Up&Up.

EN
 Wardrobe with Club swing door
 and Quid end element, Narciso bed
 with Delta feet, Look set on Epsilon
 feet and Up&Up bookshelf.







LETTO NARCISO | NARCISO BED

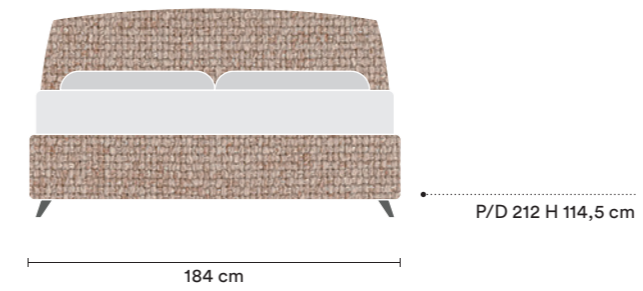

GRUPPO LOOK | LOOK SET

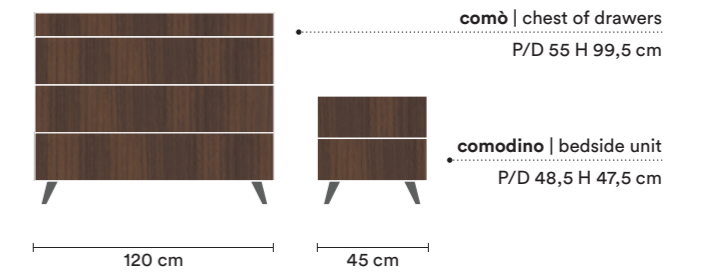

ARMADIO ANTA BATTENTE CLUB
| WARDROBE WITH CLUB SWING DOOR

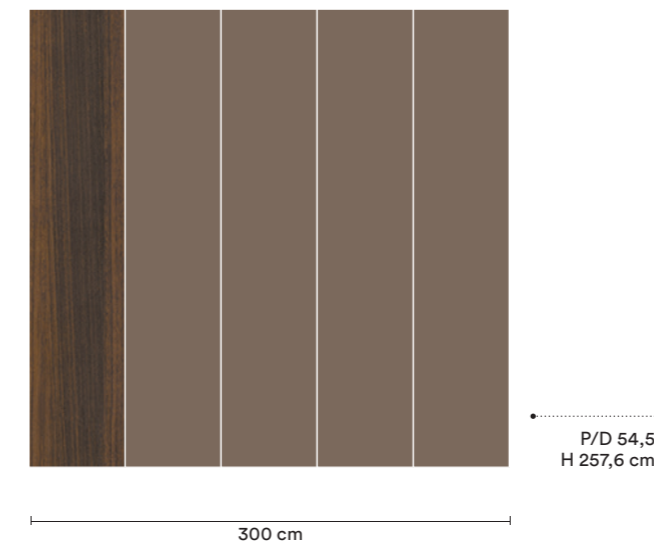

LIBRERIA UP&UP
| UP&UP BOOKSHELF

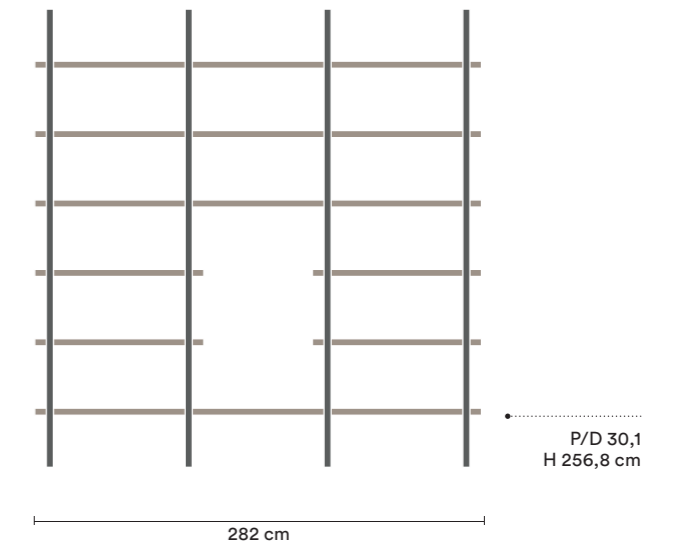

FINITURE | FINISHES

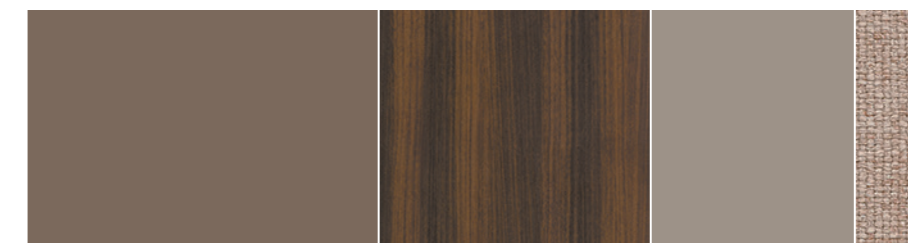

Moka
Eucalipto
Basalto
Jenny Papyrus

N32

IT
 Armadio con anta battente Club,
 guardaroba Flexo ad angolo, letto Cosy
 con giroletto Sigma e piedini Twig,
 gruppo Brick su piedini Twig,
 pomello Pin e servomuto Bernardo.

EN
 Wardrobe with Club swing door,
Flexo corner walk-in, Cosy bed
 with Sigma bed frame and Twig feet,
 Brick set on Twig feet, Pin knob
 and Bernardo valet stand.







LETTO COSY | COSY BED

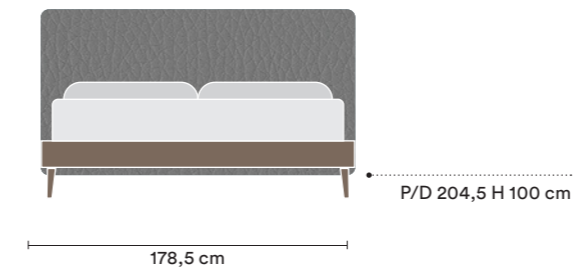

GRUPPO BRICK | BRICK SET

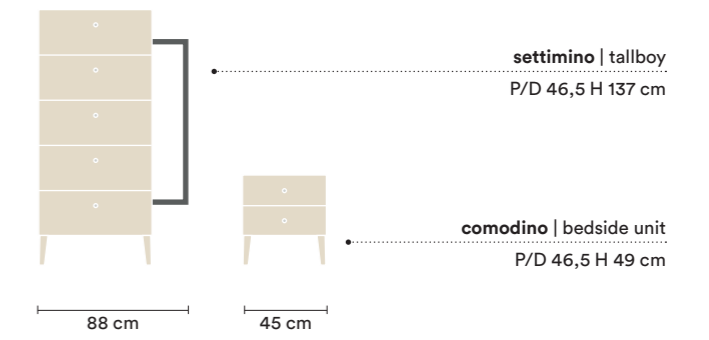

ARMADIO ANTA BATTENTE CLUB E GUARDAROBA FLEKO
| WARDROBE WITH CLUB SWING DOOR AND FLEKO WALK-IN

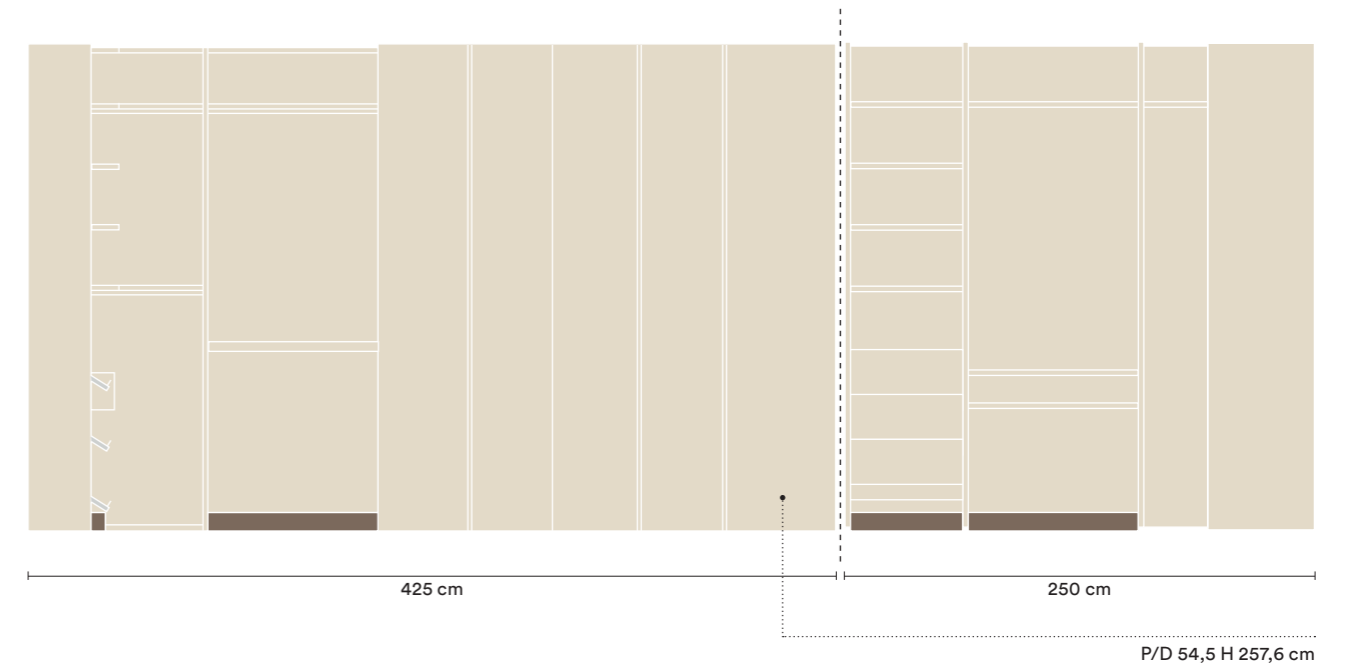

FINITURE | FINISHES



Desert
Moka
Tape Fumo

N33

IT
Guardaroba Flexo, letto Verso
con piedini Delta e gruppo
Gape su piedini Epsilon.

EN
Flexo walk-in, Verso bed
with Delta feet and Gape set
on Epsilon feet.







LETTO VERSO | VERSO BED

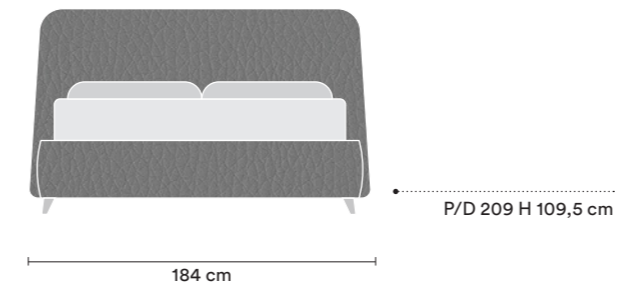

GRUPPO GAPE | GAPE SET

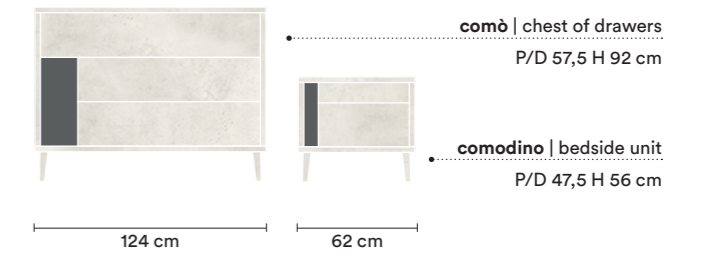

GUARDAROBA FLEXP | FLEXP WALK-IN

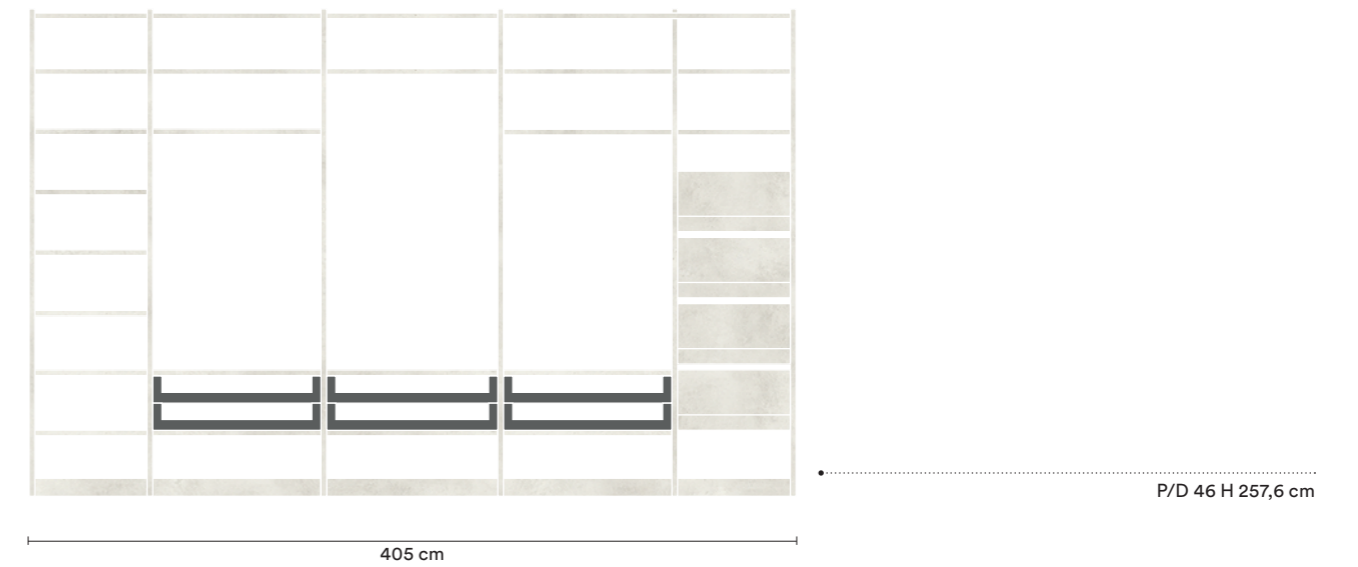

FINITURE | FINISHES

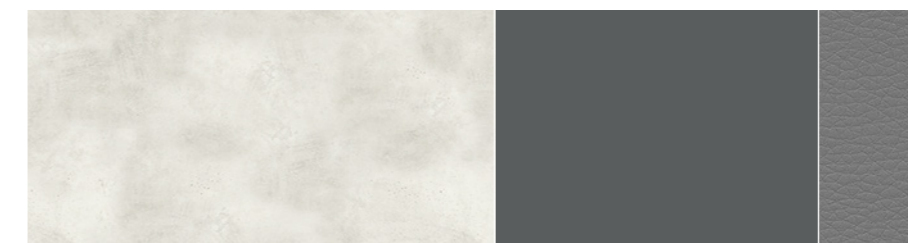

Malta
Grigio titanio
Tape Fumo

N34

IT
 Armadio con anta scorrevole
Inserto, letto Cosy con giroletto
Sigma e piedini Twig, gruppo
Bold su piedini Nume e pensile Jib.

EN
 Wardrobe with Inserto sliding door,
Cosy bed with Sigma bed frame
 and Twig feet, Bold set on Nume
 feet and Jib wall unit.





LETTO COSY | COSY BED

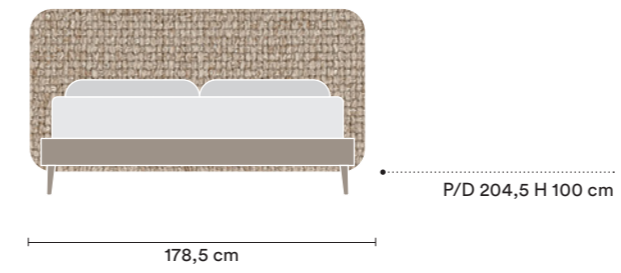

GRUPPO BOLD | BOLD SET

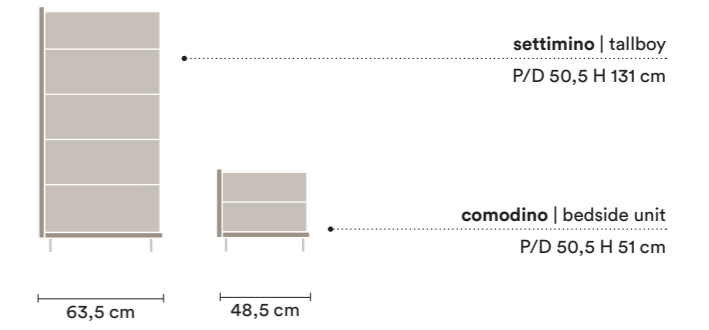

**ARMADIO ANTA SCORREVOLE INSERTO
| WARDROBE WITH INSERTO SLIDING DOOR**

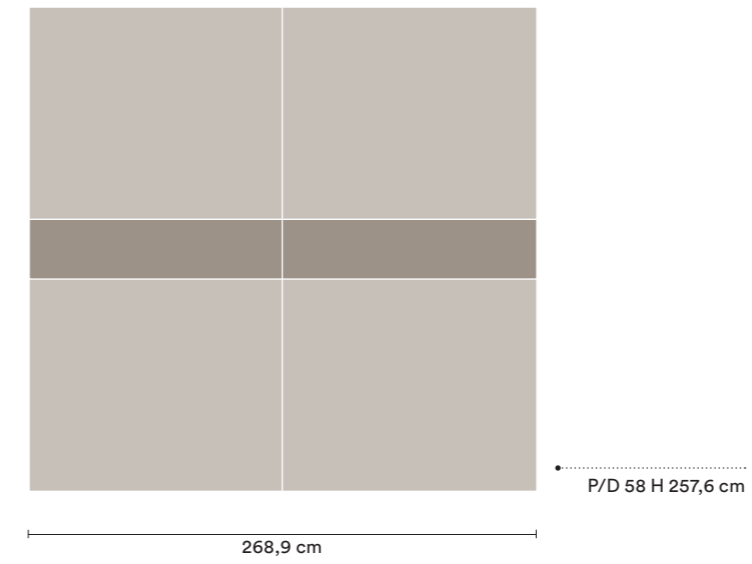

PENSILE JIB | JIB WALL UNIT

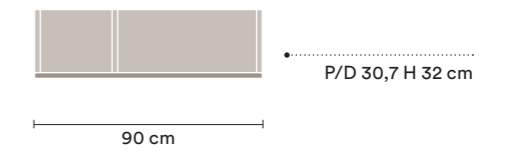

FINITURE | FINISHES



**Grigio Dorian
Basalto
Jenny Papyrus**

Complementi

Accessories

Alba

Letto con alzatina | Bed with console table



Alzatina da appoggio a parete
| Wall console table

L/W 200 P/D 26 H 78 cm



Giroletto e testiera imbottiti
| Upholstered bed frame and headboard



Panca fondo letto con cuscino
| End-of-bed bench with cushion

L/W 120 P/D 38 H 42,7 cm

**Giroletto e testiera retrofiniti
per utilizzo centro stanza**
| Rear-finished bed frame and
headboard for use in centre of room



LETTI IMBOTTITI | PADDED BEDS

Snug



Time



Unique



Line



LETTI IMBOTTITI | PADDED BEDS

Narciso



Reverso



Verso



Slim



LETTI IMBOTTITI | PADDED BEDS

Adagio



Galaxy



Gallery



Twin



LETTI IMBOTTITI | PADDED BEDS

Kiss



Pad



Tetris



Kant



Darsena

Sistema boiserie con giroletto | Panelling system with bed frame

ELEMENTI PER LA CONFIGURAZIONE | ELEMENTS FOR CONFIGURATION

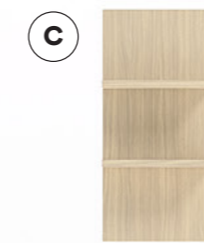
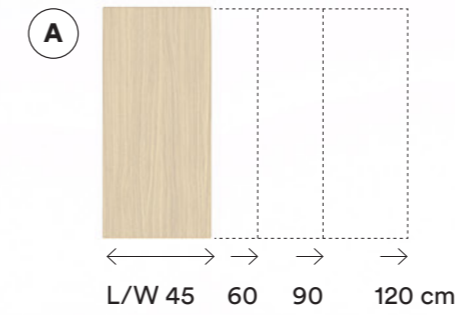

- A Pannello**
| Panel
P/D 2,6 H 96 cm
- B Pannello su misura**
| Custom made panel
P/D 2,6 H 96 cm
- C Pannello con mensole**
| Panel with shelves
L/W 45 P/D 28,6 H 96 cm
- D Pannello con mensole**
| Panel with shelves
L/W 60 P/D 28,6 H 96 cm
- E Cuscino per testiera**
| Cushion for headboard
L/W 120 cm

ESEMPI DI COMPOSIZIONI | EXAMPLE COMPOSITIONS

Variante 1 | 1 Variant
L/W 360 P/D 7,6 H 192 cm



Variante 2 | 2 Variant
L/W 360 P/D 28,6 H 192 cm



Variante 3 | 3 Variant
L/W 330 P/D 28,6 H 96 cm



LETTI IN PANNELLO | PANEL BEDS

Cosy



Con giroletto Atlante
| With Atlante bed frame

Cosy sospeso



Con giroletto Sigma
| With Sigma bed frame

Sector



Con giroletto Atlante
| With Atlante bed frame



Con giroletto Marte
| With Marte bed frame

Nadir



Con giroletto Atlante
| With Atlante bed frame



Con giroletto Giove
| With Giove bed frame

LETTI IN PANNELLO | PANEL BEDS

Leo



Con giroletto Atlante
| With Atlante bed frame



Con giroletto Marte
| With Marte bed frame

Virgo



Con giroletto Atlante
| With Atlante bed frame



Con giroletto Marte
| With Marte bed frame

Cushy



Con giroletto Atlante
| With Atlante bed frame



Alloggiamento posteriore
| Rear compartment

LETTI IN PANNELLO | PANEL BEDS

Musa



Con giroletto Giove
| With Giove bed frame



Con giroletto Marte
| With Marte bed frame

Diva



Con giroletto Giove
| With Giove bed frame



Con giroletto Marte
| With Marte bed frame

Mushy



Con giroletto Atlante
| With Atlante bed frame



Alloggiamento posteriore
| Rear compartment

LETTI IN PANNELLO | PANEL BEDS

Elfo



Con giroletto Atlante
| With Atlante bed frame

Tais



Con giroletto Giove
| With Giove bed frame

Normale



Con giroletto Atlante
| With Atlante bed frame

GRUPPI | BEDROOM SETS

Quadro



Look



Leader



GRUPPI | BEDROOM SETS

Label



Chic



Bold



GRUPPI | BEDROOM SETS

Brick



Stick



Tetris



GRUPPI | BEDROOM SETS

Tower



Gape



Tulip



Finiture

Finishes

COLORI | COLOURS



Bianco opaco



Bianco UV

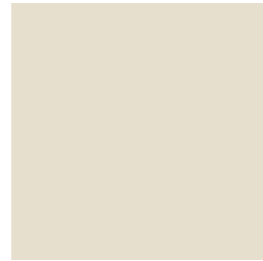

Desert



Canapa

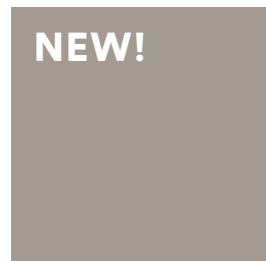

Basalto



Moka



Grigio titanio

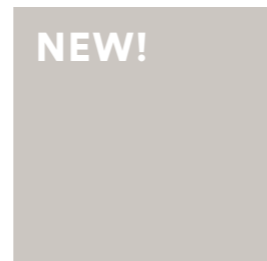

Grigio Dorian



Agave

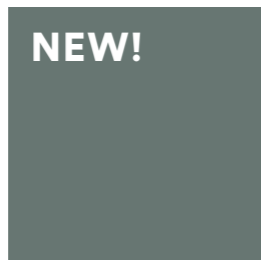

Verde Alpi

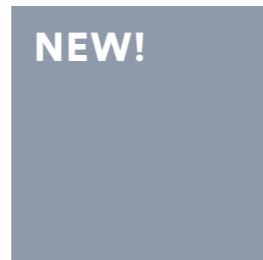

Cadaques



Blu opale

LEGNI | WOODS



Rovere white



Rovere Dorian



Ciliegio bianco



Noce naturale

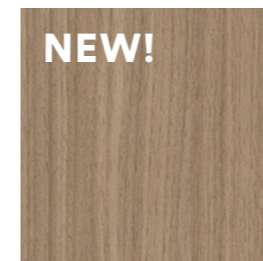

Noce

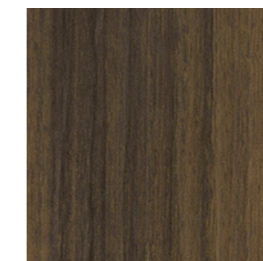

Eucalipto

MATERICI | TEXTURES



Cemento Masdar



Feltro



Leather grey



Malta

TESSUTI | TEXTILES

TESSUTO JENNY

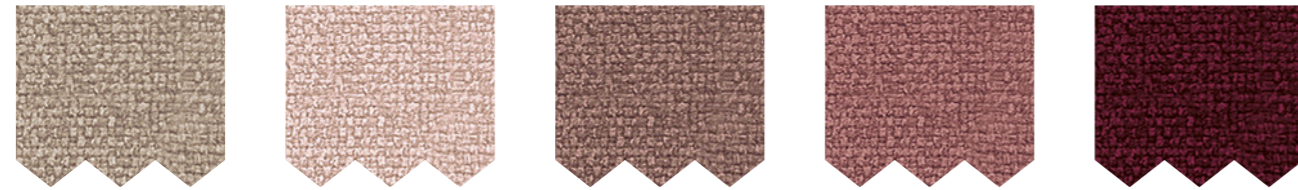

Papyrus Pill Coriander Nox Bombay



Strawberry Carioca Zinc Grey Greystone

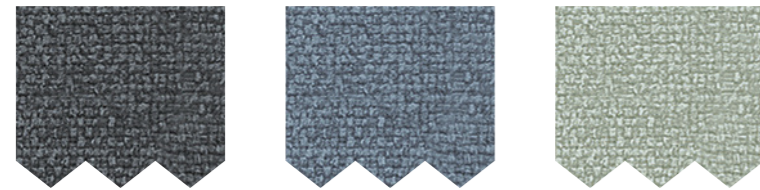

Smoke Steel Water green

SIMILPELLE TAPE

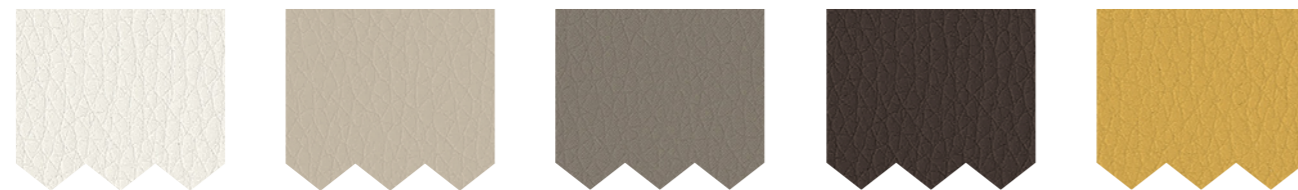

Ottico Seta Tenda Testa di moro Mais

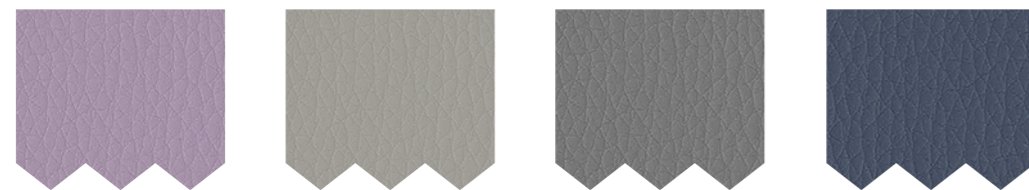

Violetto Creta Fumo Oceano

TESSUTI | TEXTILES

TESSUTO ECOCHIC



Dorian Desert Domy Zafferano



Opale Titanio

SIMILPELLE ECOCHIC

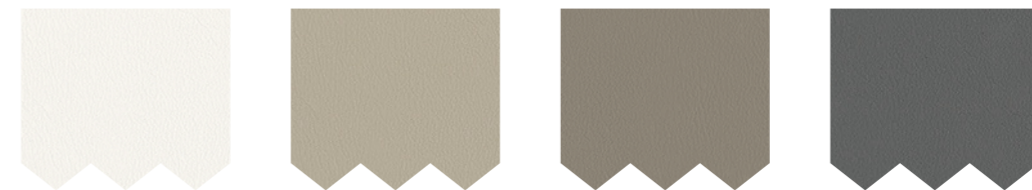

Bianco candido Travertino Limo Elephant



Fiordaliso Malva Senape

TESSUTO KENYA

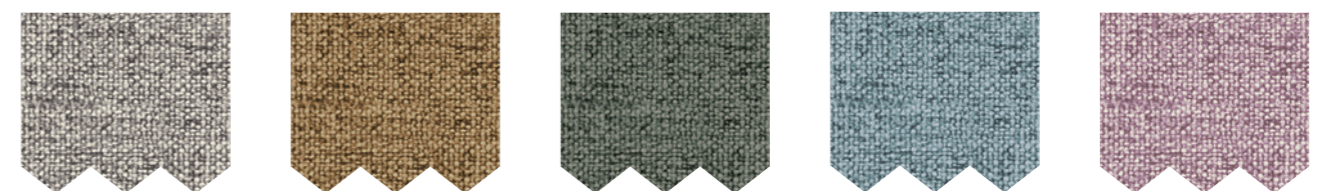

Taupe Camel Forest Turquoise Pink

L'habitat contemporaneo giovane e dinamico

The young and dynamic contemporary habitat



N01 p.10



N02 p.22



N03 p.30



N04 p.38



N05 p.44



N06 p.52



N07 p.56



N08 p.62

La residenza calda e materica

The warm and textured residence



N09 p.72



N10 p.80



N11 p.86



N12 p.92



N13 p.100



N14 p.106



N15 p.110



N16 p.114



N17 p.120



N18 p.126



N19 p.130

L'appartamento d'epoca tra ieri e oggi

The period apartment of past and present



N20 p.138



N21 p.148



N22 p.156



N23 p.162



N24 p.170



N25 p.176



N26 p.182



N27 p.188

Il loft essenziale e luminoso

The bright and essential loft



N28 p.198



N29 p.208



N30 p.214



N31 p.220



N32 p.226



N33 p.232



N34 p.238

Rispetto dell'ambiente

Respect for the environment



Economia circolare

Produciamo strutture e ante in nobilitato costituite da pannelli ecologici provenienti da fornitori certificati FSC® che utilizzano legno pre e post-consumo a cui viene data una seconda vita in virtù di un'economia circolare che si autoalimenta, senza andare a intaccare il nostro patrimonio forestale.

Circular economy

We produce melamine-faced structures and doors consisting of ecological panels produced by FSC® certified suppliers who use pre- and post-consumer wood, which is given a second life thanks to a self-perpetuating circular economy, without impacting our existing forests.



Materiali eco-friendly

Utilizziamo vetro e alluminio, riciclabili all'infinito per realizzare prodotti resistenti e di grande impatto estetico, e PET per superfici sicure che non rilasciano alcuna emissione tossica durante il ciclo di produzione e utilizzo.

Eco-friendly materials

We use glass and aluminium, infinitely recyclable materials to develop resistant products with a high visual impact, and PET for safe surfaces without toxic emissions either during production or use.



Diagnosi energetica

Monitoriamo costantemente i consumi totali e definiamo azioni di miglioramento sistemico per ottimizzare il nostro impatto energetico.

Energy diagnosis

We constantly monitor our total consumption and define systemic improvement actions to optimise our energy impact.



Imballaggio

Impieghiamo solo cartoni realizzati con carta riciclata, riducendo progressivamente l'uso della plastica per sostituirla completamente con materiali green.

Packaging

We use only boxes made of recycled paper, gradually reducing the use of plastic, to be completely replaced with eco-friendly materials.



Durabilità dei prodotti

Progettiamo prodotti con una maggiore vita utile per ridurre i rifiuti e offrire alti standard qualitativi.

Product durability

We design products that last longer to reduce waste and offer high quality standards.



Attitudine green-living

Abbiamo azzerato l'utilizzo della plastica negli uffici e nella produzione installando distributori d'acqua e recuperiamo tutti i rifiuti che produciamo con la nostra attività industriale.

Green-living attitude

We have eliminated the use of plastic in our offices and production department by installing water dispensers, and recover all the waste we produce through our industrial activities.



Logistica interna

Abbiamo ottimizzato tutte le movimentazioni all'interno dell'azienda per ridurre al minimo lo spreco di risorse energetiche e la produzione di CO₂.

Internal logistics

We have optimised all internal company logistics to reduce energy wastage and CO₂ production to a minimum.



Ottimizzazione degli spazi

Riduciamo lo spreco dei materiali da costruzione ottimizzando gli spazi con le nostre soluzioni di arredo che si adattano alle diverse architetture grazie alla loro ampia modularità e personalizzazione.

Space optimisation

We reduce building material waste by optimising spaces with our own furniture solutions, perfectly adaptable to different architectures thanks to their extensive modularity and customisation.



Innovazione

Siamo sempre alla ricerca di materiali e materie prime uniche che ci permettono di proporre sul mercato prodotti di alta qualità dal design distintivo. Abbiamo introdotto un sistema di intelligenza artificiale che pianifica la produzione, massimizza la produttività e facilita le operazioni di logistica e smistamento riducendo, in maniera significativa, gli sprechi.

Innovation

We are always on the lookout for unique and raw materials allowing us to offer the market high-quality products with a signature design. We have introduced an artificial intelligence system that plans production, maximizes productivity and facilitates logistics and sorting operations by reducing waste significantly.



Tecnologie green

Scegliamo materiali naturali al 100% resi straordinari da processi innovativi come la tecnologia di sinterizzazione che permette di creare pietre ceramiche senza l'utilizzo di colle e sostanze inquinanti. Abbiamo adottato l'utilizzo di vernici bio certificate Greenguard che garantiscono basse emissioni e una migliore qualità dell'aria negli ambienti domestici.

Green technologies

We chose 100% natural materials with an excellent performance from innovative processes such as sintering technology which allows ceramic stone to be created without using adhesives or polluting substances. We have adopted the use of Greenguard certified organic paint that ensure low emissions and better air quality in home environments.



Trasporto

Organizziamo le spedizioni ottimizzando gli spazi e i percorsi delle consegne per ridurre le emissioni di CO₂ sul pianeta.

Transport

We organise shipments by optimising space and delivery routes to reduce CO₂ emissions on the planet.



Progetti Speciali

Aderiamo al Furniture Pact, un progetto ideato dal Sustainability Lab di SDA Bocconi School of Management, che mira a supportare le aziende della filiera del legno-arredo verso l'adozione di modelli gestionali sempre più sostenibili.

Transport

We are joining the Furniture Pact, a project conceived by the Sustainability Lab of SDA Bocconi School of Management, which aims to support companies in the wood-furniture supply chain toward the adoption of increasingly sustainable management models.

La Colombini S.p.A. si riserva il diritto di apportare, senza alcun preavviso, le modifiche che riterrà più opportune al fine di migliorare il prodotto.

La Colombini S.p.A. reserves the right to make any changes, without advance notice, that feels needed in order to improve the product.

Credits

concept, art direction and graphic design
dogtrot

6-42; 72-104; 138-167; 198-218
dogtrot

44-66; 106-134; 170-193; 220-240
Studio Ferriani

color separation
Bieffe

COLOMBINI S.p.A.

Azienda certificata UNI EN ISO 9001
Azienda certificata UNI EN ISO 14001

Strada Ca' Valentino, 124
47891 Falciano
Repubblica di San Marino

Telefono da Italia 0549 943573
International calls +378 0549 975948

www.colombinicasa.com
www.colombinigroup.com

The logo for Febal Casa, featuring the words "febal" and "casa" stacked vertically in a white, lowercase, sans-serif font, set against a solid red square background.

febal
casa

Colombini S.p.A.
Strada Ca' Valentino, 124
47891 Falciano Repubblica di San Marino
Telefono da Italia 0549 943 573
International calls +378 0549 975 948
www.febalcasa.com